



THE OILS REFINING PROCESS AND CONTAMINANTS IN EDIBLE OILS: A REVIEW

Souleymane Zio¹

Hama Cisse²

Oumarou Zongo³

Flibert Guira⁴

Francois Tapsoba⁵

Namwin Siourime Somda⁶

Fatoumata Hama-Ba⁷

Laurencia Touloumde Songre-Ouattara⁸

Cheikna Zongo⁹

Yves Traore¹⁰

Aly Savadogo¹¹⁺

^{1,2,3,5,9,10,11} Department of Biochemistry and Microbiology, Laboratory of Applied Biochemistry and Immunology, University Joseph KI-ZERBO, Burkina Faso.

¹Email: ziosouleymane@yahoo.fr Tel: (226)70823335

²Email: cissehama70@gmail.com Tel: (226)79100222

³Email: ozongo25@gmail.com Tel: (226)71057944

⁴Email: tapsobaf@gmail.com Tel: (226)76668843

⁵Email: zcheik@yahoo.fr Tel: (226)76579603

⁶Email: ytraore@yahoo.com Tel: (226)70233896

⁷Email: alysavadogo@gmail.com Tel: (226)79385707

⁴Department of Biochemistry and Microbiology, Laboratory of Applied Biochemistry and Immunology, University Joseph KI-ZERBO, Burkina Faso; Gaoua Polytechnic University Center, Burkina Faso.

⁷Email: flibertguira@gmail.com Tel: (226)70352725

⁶Department of Biochemistry and Microbiology, Laboratory of Applied Biochemistry and Immunology, University Joseph KI-ZERBO, Burkina Faso; Department of Food Technology, Research Institute of Applied Sciences and Technology, Burkina Faso.

⁹Email: landsom60@yahoo.fr Tel: (226)78684411

^{7,8}Department of Food Technology, Research Institute of Applied Sciences and Technology, Burkina Faso.

⁸Email: hamafatou@yahoo.fr Tel: (226)70283860

⁸Email: laurenciaouattara@yahoo.fr Tel: (226)70278633



(+ Corresponding author)

ABSTRACT

Edible oils are widely consumed foods. These oils come from various animal materials raw and vegetable products. Edible oils are prone to many contaminants. Contaminants can be found at all levels from oilseed production to conservation through refining processes and end up in oils. The contaminants origin may be of endogenous or exogenous. These are water, phosphorus, non-visible insoluble compounds, free fatty acids, residual hexane, benzo [a] pyrene, pesticides, dioxins, mycotoxins, mineral oils, cargo residues, minerals such as iron, copper, lead, gossypol, many primary and secondary oxidation products, etc. To eliminate or limit these compounds having a nuisance or toxicity for the consumer, it is allowed the refining of oils (chemical, physical or enzymatic). In addition, the regulatory limits of anti-nutritional factors in edible oils have been set in order to obtain quality oils and to guarantee the health of consumer living in developing country. This results in analytical methods developed for quantitative and qualitative evaluation of oils intended for human consumption.

Article History

Received: 28 October 2019

Revised: 3 December 2019

Accepted: 8 January 2020

Published: 24 February 2020

Keywords

Edible oil
Refining
Contaminant
Mycotoxin
Pesticide
Gossypol.

Contribution/Originality: This study on the contaminants of edible oils contributes to knowledge the sanitary consumption of these oils and their analytical methods. Previously, the contaminants in the oils did not experience infatuation. Our study focuses on pesticides, mycotoxins and gossypol which are anti-nutritional factors present in edible oils widely consumed.

1. INTRODUCTION

Humans have always been interested in lipids by burning fatty substances, the caveman knew how to light up and the Egyptian of old times knew how to isolate the oils and fats so that they could use them as well in cosmetology and medicine. Many seeds, animal fats have been cited in old texts testifying to the empirical

knowledge of our forefathers (Louis, 2013). In 1889, Claude Bernard's work opened the way to understanding the role of lipids in human body (Klere, 1992). Lipids or dietary fats include both oils and fats of vegetable or animal origin. They are usually differentiated by their melting point.

Generally, oils are liquid at 15 ° C, while fats are more or less solid at this same temperature (Lecerf, 2011). Lipids are present in all animal raw materials (meat, fish, milk, eggs) and vegetables (grains, seeds, fruits) (Genot and Michalski, 2010). The raw materials for obtaining oils of plant origin can be divided into three groups. These are fruits mesocarps (Avocado, olive, palm), shell fruits and nuts (peanut, balanites, coconut, shea butter, palm kernel, neem) and seeds (cotton, rapeseed, sesame, sunflower) (Koné, 2001). In fact, all seeds, fruits and almonds contain oil, but only oilseeds are used to produce oil industrially and are grown for this purpose (Vaitilingom, 2007).

Fatty substances of animal origin come from pork fats or cattle, but mainly from certain products of deep-sea fishing (Benabid, 2009). All these fats and oils all have nutritional, sensory and technological roles. There are many scientific results demonstrating that diet is a key modifiable factor able to influence the incidence of many chronic diseases (Di Renzo *et al.*, 2019). Recent scientific studies put in evidence the key role in the development of diseases such as cancer and neurodegenerative. As a result, consumers are exposed to some toxic contaminants found in foods (Engel *et al.*, 2014). Lipids are part of the concerned foods. Owing to their property, fatty acids, in particular unsaturated fatty acids, come in many food technology formulations. These lipids are sensitive to oxidation, altering lipid-soluble components such as vitamins and pigments. In addition to oxidation, lipids contain endogenous (erucic acid, cycloprenic acid and gossypol) and exogenous anti-nutritional factors such as mycotoxins and pesticides (FAO, 1993). The main factors affecting the presence of contaminants in a vegetable oil are different from one stage to another of the transformation process. Contaminants can be found at all levels from oilseed cultivation to conservation through refining processes (Lacoste *et al.*, 2005).

This review highlights on the one hand the refining of vegetable oils and their influence on the composition of oils. On the other hand, contaminants such as pesticides, mycotoxins and gossypol that are toxic to consumers, the methods used for their disposal or decontamination and the analytical methods used for their analysis.

2. ELIMINATION OF UNDESIRABLE COMPOUNDS FROM EDIBLES OILS

2.1. Edibles Oils Refining

Crude vegetable oils are produced during the process of oilseeds trituration. This operation, which has only changed relatively a little during the pass sixty (60) years, has three main stages (Evrard *et al.*, 2007; Bauer *et al.*, 2010; Fine *et al.*, 2016). This is oilseeds preparation, the mechanical extraction through a press and solvent extraction of the oil contained in the cake or scales or oilcake estimated between 15 and 20%. Crude pressure and extraction oils are refined to provide consumers with quality oil that is free impurities, contaminants and meets regulatory requirements (Evrard *et al.*, 2007). The purpose of refining is therefore to maintain or improve the organoleptic characteristics (neutral taste and odor, limpidity, light yellow color), nutritional characteristics and the stability of oils. For this purpose, refining uses several steps to eliminate unwanted compounds (gums, waxes, free fatty acids, pigments, metal traces, volatile odor compounds) and contaminants potentially present in the raw materials, while controlling the formation of new undesirable compounds (Evrard *et al.*, 2007). In other words, the refining is a succession of stages of physical and chemical treatments in order and variable number depending on the degree of oil refining that is desired.

2.2. Types of Edible Oils Refining

There are two oils refining types like chemical refining and physical refining (also called neutralizing distillation). Chemical refining removes free fatty acids by a neutralization step with sodium hydroxide; the neutralizing distillation removes these undesirable compounds (de-acidification) by distillation under high vacuum with steam injection. The chemical oils refining has four stages (Evrard *et al.*, 2007). Degumming consists to add

the acid and/or water (75% phosphoric acid or citric acid) to crude oils, eliminates the 0.2 to 1.8% phospholipids they contain. Dijkstra (1998) reported that there are several types of degumming (water degumming, acidic degumming, dry degumming, enzymatic degumming, membrane degumming and Ethylene-diamine-tetra-acetic or EDTA degumming). Neutralization of free fatty acids, whose contents in oils vary between 0.3 and 5%, are extracted. Neutralization also eliminates soaps, phospholipids, metals, some pigments, oxidation products, and some contaminants. The bleaching or discoloration is carried out at 90-110°C and 0.2 to 2% of adsorption agents such as bleaching earths are introduced and brought into contact for 30 min with stirring and under high vacuum. The oil is cooled and filtered to extract the remaining pigments as well as soap residual traces and phospholipids, polar oxidation products and contaminants. Deodorization removes volatile compounds, flavors, hydroperoxides and some contaminants in the oil at 180-240 °C by ultra-high vacuum water vapor entrainment. Evrard *et al.* (2007) reported that another step called "winterization" or dewaxing still called crystallization takes place most often between discoloration and deodorization, consists in causing the waxes crystallization contained in some oils by cooling the oil to 0-4 °C (sunflower oil, cottonseed oil, maize oil, grape seeds oil, olive pomace oil, safflower oil). Physical refining or refining by neutralizing distillation follows the same steps as chemical refining except that there is no neutralization step with soda. Chemical refining removes free fatty acids by a neutralization step with sodium hydroxide; neutralizing distillation removes these undesirable compounds (de-acidification) by distillation under high vacuum with steam injection (Pages *et al.*, 2010). The Figure 1 show the chemical and physical refining stages and compounds eliminated. There is also another type of refining called enzymatic refining still called EnzyMax process. The enzymatic process consists in transforming the non-hydratable phospholipids into hydrophilic lyso-phospholipids under the action of phospholipase. It is considered the most recent method developed by Lurgi (enzymax) (Gibon and Tirtiaux, 1998). This enzymatic degumming or enzymatic demucilagation is a powerful physical process that produces higher oil yields (Gibon and Tirtiaux, 1998).

According the Figure 2, the EnzyMax process consists of four steps namely the adjustment of optimal conditions for the enzyme an optimum pH 5 with a citrate buffer and the optimum temperature about 65 °C; the addition of the enzyme solution; the enzymatic reaction and separation of lyso-phosphatide from the oil at about 75 °C (Dahlke, 1998).

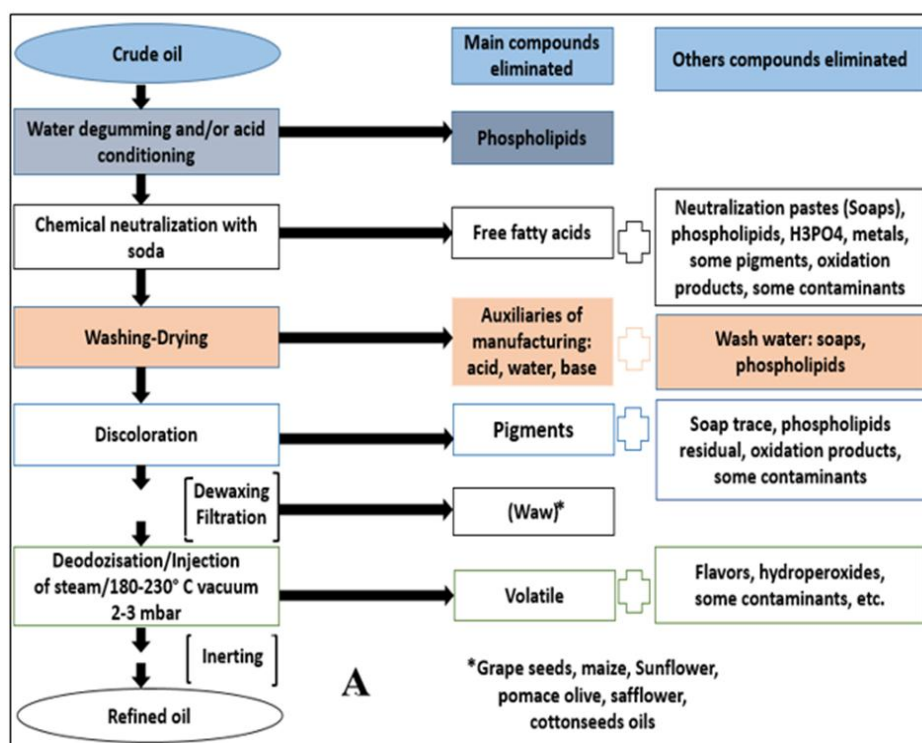

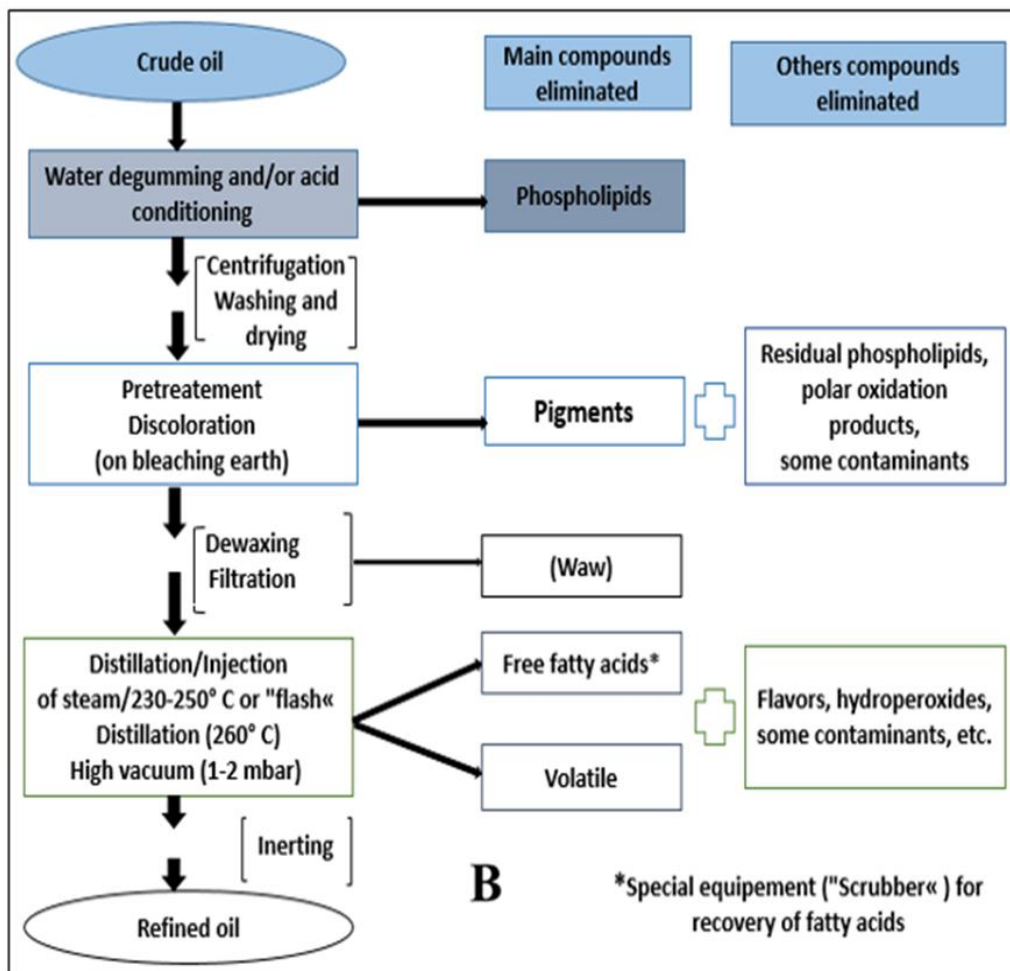

Figure-1. Stages and compounds eliminated.

Legend: Chemical (A), Physical oils refining (B)
 Source: Pages *et al.* (2010).

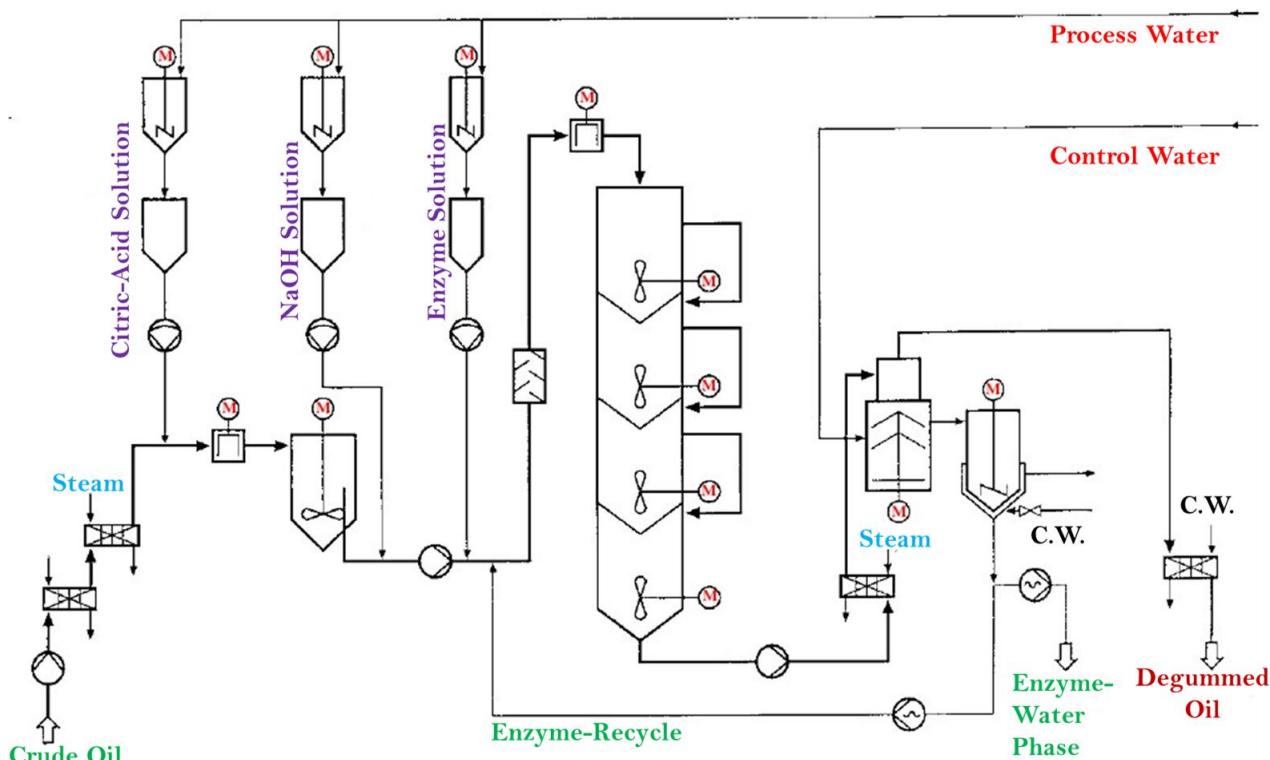

Figure-2. Flow diagram of the EnzyMax process.

Source: Dahlke (1998).

3. EDIBLES OILS CONTAMINATION

3.1. Edibles Oils Contaminants

The complete definition of food contaminant comes from Coumoul (2016). Thus, food contaminants are substances of very varied nature that are present in the diet because of either a natural contamination by an organism (mycotoxins) or an anthropogenic contamination related to the production of food (pesticides), food modification processes (cooking and smoking with the example of polycyclic aromatic hydrocarbons) or transfer processes between the containers and the contents (bisphenols in bottles water and cans) (Coumoul, 2016).

Three types of natural contamination can be distinguished including contamination by a microorganism or abiotic, anthropogenic contamination and non-neglected contamination, breastfeeding (Guéguen *et al.*, 2011; Marin *et al.*, 2013). More specifically, and apart from the natural constituents of oils, toxic contaminants can be found in oils. Therefore, the contaminants may be endogenous or exogenous origin. These are water or moisture, phosphorus, insoluble non-visible compounds, free fatty acids, peroxides, residual hexane, Benzo [a] pyrene, pesticides, dioxins, mycotoxins including aflatoxins (aflatoxin B1, aflatoxin B1, B2, G1, G2), mineral oils, cargo residues iron, copper and lead (Pages *et al.*, 2010). Also, in cotton products, the presence of cyclopropenoic fatty acids (malvalic and sterculic acids) is a potent inhibitor of the Δ^9 desaturase enzyme activity involved in the transformation of fatty acids (Schmidely and Sauvart, 2001).

These compounds have limited maximum values in foodstuffs according to standards or regulations. Alteration of edible oils generates toxic compounds. This is the case with oxidation, which results in the formation of oxy-cholesterol, malonadehyde, endoperoxides, acrolein, and peroxide polymers (Kim and Min, 2008; Farhoosh and Esmailzadeh, 2009). Apart from mycotoxins produced by fungi, microorganisms can be found in oils whose limits have been defined. These include total mesophilic flora (less than 105/ml), yeasts (10/ml) and moulds (10/ml), total coliforms (25/ml), sulphito-reducing anaerobes (0/ml), *Staphylococcus aureus* (0/ml) and *Salmonella* (0/25ml) according to Codex Alimentarius CAC/GL-21-1997 standard (Abalo, 2017). No microbial multiplication being possible in the absence of water, the plants oils and fatty anhydrous are no problem microbiological stability (Jouve, 1993; Pages *et al.*, 2010). The Oil deodorization treatment refined constitutes a sterilizing treatment very effective in obtaining oils of impeccable microbiological quality and meets the specifications of vegetable oils (Pages *et al.*, 2010).

The main undesirable compounds present in a vegetable oil are different from one stage to the next and are influenced by many factors. During the culture they are lead, cadmium, dioxins, phytosanitary residues and mycotoxins whereas during the trituration and the refining it is hexane, the catalysts, the Trans fatty acids which are present. Compounds present during conditioning are the monomers or solvents (styrene) and during of used Oxy-phytosterols, Trans fatty acids, furans, acrylamide. Their presence is influenced by factors such as extraction solvents, direct drying, light, pressure, water and temperature (Lacoste *et al.*, 2005).

3.2. Edible Oils Degradation

During the production, storage and processing of fruits or oilseeds, hydrolysis (chemical or enzymatic) and oxidation are the main pathways of lipid alteration. In addition, there is thermal weathering by heating at temperatures above 100 or even 180 °C with formation of polymers and cyclic compounds. All fatty substances undergo during their conservation or their use of oxidative alterations (Judde, 2004).

The oxidation of lipids is one of the main causes of the deterioration of food quality. It decreases the nutritional value, alters the taste, modify the texture and appearance of the food with the appearance of a characteristic "rancid" flavor that modifies the marketability of the product (Warner *et al.*, 1989; Judde, 2004). It can reduce its shelf life and limit the virtues of lipids in functional foods (Sun *et al.*, 2011). Hydroperoxides, primary products of the reaction, are unstable molecules. They decompose under the effect of heat or metals giving rise to secondary products. Among these, volatile compounds are the origin of odor modification some oxidized products (Villier and

Genot, 2006). The oxidation products of fatty acids and cholesterol oxides have been implicated in mutagenesis, carcinogenesis and etiology of coronary heart disease (Addis and Warner, 1991). Edible oils used in cooking at very high temperatures and in presence of oxygen undergo thermo-oxidation, polymerization and hydrolysis (Nzikou *et al.*, 2009; Ali, 2010). The toxicity of oxidized edible oils is very low to harm human health (Nolen *et al.*, 1967).

However, chronic reuse of used oil can lead to excessive accumulation of oxidation products and, as a result, increased toxicity (Halliwell and Gutteridge, 1984; Addis, 1986; Frankel, 1989; Kubow, 1990). These products are absorbed and incorporated into membrane phospholipids inducing a change in membrane fluidity (Staprans *et al.*, 1999). Ingesting thermo-oxidized oil induces an excessive accumulation of lipid peroxides in the liver and kidney resulting in metabolic disorders that occur, such as a reduction in the antioxidant activity of glutathione peroxidase (Hui, 1996; Nwanguma *et al.*, 1999; Sheen *et al.*, 1999). Lipid oxidation can result in the formation of potentially toxic oxidation products like oxy-cholesterol, malondialdehyde, endoperoxides, acrolein, peroxide polymers (Kim and Min, 2008; Farhoosh and Esmailzadeh, 2009).

These toxic molecules are responsible for the alteration of deoxyribonucleic acid (DNA) and proteins (Laguerre *et al.*, 2007). The oils oxidation has three major impacts such as nutritional and organoleptic impact (vitamins and essential fatty acids degradation, abnormal flavors, color change, nutrients oxidation, toxic compounds formation); health impact (cytotoxic and mutagenic effects and carcinogen) and the economic impact (loss of market value) (Benjelloun, 2014). Chronic ingestion of oxidation products would be the most worrying consequence in nutrition and health terms of lipid oxidation (Pearson *et al.*, 1983; Addis, 1986; Kubow, 1990; Kamal-Eldin and Appelqvist, 1996; Riemersma, 2002). For a better conservation of the oils, it is essential to limit the exposure to the light, heat or to reduce the availability of oxygen by inerting the oils under nitrogen are effective means to fight against their oxidation. The addition of protection by antioxidants, some of which are endogenous to the raw materials from which the oils originate, would be a source of enhanced stabilization (Cuvelier and Maillard, 2012).

3.3. Edibles Oils Adulteration

The large price difference between oils, especially virgin oils and refined oils, can lead to temptations to falsify by introducing all or part of a lower cost oil into a higher priced oil (Ollivier, 2003). The parameters commonly used for the detection of refined oil in a virgin oil are the determination of the specific extinction coefficient in the ultraviolet at 270 nm (K₂₇₀) and the determination of trans fatty acids, by gas chromatography (Maata *et al.*, 2011). However, these analytical criteria are not sufficient to prevent fraud. As a result, the dosage of stigmastadienes has been integrated into the regulatory analytical tool such as olive oil and argan oil (Ollivier, 2003). One method used to discover adulterations is to determine the composition of fatty acids from the chromatographic analysis of their methyl esters (Casas *et al.*, 2009). The similarity of fatty acids in oils makes the oils authenticity difficult. Also, many factors influence fatty acid profiles, such as climate, plant preparation region, and growing environment (Wenzl *et al.*, 2002; Camin *et al.*, 2010). The sterols content can be used to determine the oils purity and adulteration (Lerma-García *et al.*, 2009). The use of triglyceride analysis is used for adulteration research (Ollivier, 2003) but is not suitable for some oils as suitable for the search for adulterations of virgin olive oils by oils of hazelnut and almond. A use of propionitrile makes it possible to better highlight adulterations. The levels of tocopherols and tocotrienols in vegetable oils are identity factors of vegetable oils (Codex, 1999). The application of high resolution gas chromatography for detection of adulterations in vegetable oils with better sensitivities than traditional techniques (Gromadzka and Wardencki, 2011).

4. MYCOTOXINS

4.1. Origin and Definition of Mycotoxins

During Antiquity, the first outbreaks of mycotoxins in many parts of Europe in the tenth century were described as ergotism, later called "Saint Anthony's Fire" or "Ardent Fever" because of the burning sensation felt by the victims. The disease was responsible for gangrene of the extremities, hallucinations and convulsions (Gauthier, 2016) and due to the consumption of rye contaminated with ergot alkaloids produced by the mould *Claviceps purpurea* (Bové, 1970). Later, food-toxic Aleucine caused by mycotoxins (Trichothecenes) first appeared in Russia during 1930, or the "X" turkey disease caused by other mycotoxins (Aflatoxins) in Great Britain at 1960.

Many mycotoxins have been discovered, the last of which in 1988 are the fumonisin group (Yiannikouris and Jouany, 2002). When ingested, inhaled or absorbed through the skin, they impair the ability to react and cause illness or death in the human being or animal, including birds (Pitt, 1996). The term Mycotoxin comes from the ancient Greek "*Mycos*", which means mushroom, and the Latin "*Toxicum*" meaning poison. They are origin of harmful biological effects known on the term of mycotoxicoses (Gauthier, 2016). Mycotoxins are secondary metabolites of microscopic fungi (micromycetes) that can grow on the plant in the field or being harvested, transported or stored (Huybrechts *et al.*, 2013). These are small molecules that are poorly soluble in water, generally non-degradable by living organisms and very heat stable (up to 250 °C) since we can find them in food after cooking or even after sterilization and at extreme pH. Their life in the food is longer than the moulds that synthesized them. The secondary metabolites of moulds are not all mycotoxins (Guezlane-Tebibel *et al.*, 2016). They are molecules of low molecular weight (MW <1000 Da), of various chemical origins like amino acid derivatives, poly-aceto-acids, fatty acids or terpenes (Betina, 1994). Determination of the metabolic patterns of biosynthesis of certain mycotoxins has been made possible by the use of enzyme inhibitors and metabolic precursors (Luchese and Harrigan, 1993). Mycotoxins have three main biosynthetic origins such as the poly-acetate, the terpene and the amino acid pathways (Tabuc, 2007). Mycotoxins are produced at different levels (agricultural production, harvesting, transport, storage, food processing) and are major challenges for global food security systems, health, nutrition and economies (Murphy *et al.*, 2006).

4.2. Mycotoxins Typology

Mycoflora is estimated at between 200,000 and 300,000 species. About 25% of food products would be contaminated with fungal toxins. More than 400 mycotoxins have been identified. Thirty (30) have disturbing toxic properties and twenty (20) are present in foods in sufficient quantity to affect the health of humans and animals (Mannon and Johnson, 1985). Many types of mycotoxins are found in foods. Some contaminate human nutrition and are toxic to human health. According to AFSSA (French Food Safety Agency) (2009) mycotoxins are produced by moulds belonging in particular to the genera *Aspergillus*, *Penicillium* and *Fusarium*. Aflatoxins, ochratoxins, zearalenone, citrinin, patulin, trichothecenes, fumonisins are of greatest concern (D'Mello *et al.*, 1997; Scudamore and Livesey, 1998) and the best known are aflatoxins, deoxynivalenol, ochratoxin A, fumonisins, zearalenone, patulin, toxins T2 and HT2; the least frequently detected are nivalenol, moniliformine, citrinine, penicillic acid, roquefortine, mycophenolic acid, sterigmatocystine, cyclopiazonic acid, verruculogen, griseofulvin, citreoviridine, gliotoxin, monacolin or mevinolin, sporidesmines, satratoxins, enniatines, beauvericin, ergot alkaloids and many others (Huybrechts *et al.*, 2013).

In the agri-food and health sector, aflatoxins, ochratoxins, zearalenone, patulin, trichothecenes and fumonisins are the most important mycotoxins (Brochard and Bâcle, 2009). Among the mycotoxins, aflatoxins are the most known and the most toxic. They can be identified in almost all cereals and groundnuts. These compounds are hepatotoxic and potent hepato-carcinogens synthesized by *Aspergillus flavus* and *Aspergillus parasiticus* during food storage under hot, humid conditions. Aflatoxins group is the best known, studied and most regulated. The most important are AFB1, AFB2, AFG1, AFG2 and AFM1 (from AFB1). Other aflatoxins are AFQ1 (AFM1) and

aflatotoxicol. The order of decreasing toxicity of aflatoxins are AFB1, AFM1, AFG1, AFB2 and AFG2 (Brochard and Bâcle, 2009). Aflatoxin B1 (AFB1) is the most common and most toxic form for mammals (Tabuc, 2007) and has the highest carcinogenic potential (Dieme *et al.*, 2016). The biotransformation of the functional groups of AFB1 leads to a reduction of toxicity during hydroxylation's (Aflatoxin Q1 (AFQ1)) or O-demethylations (Aflatoxin P1 (AFP1)) (Firmin, 2011). *Aspergillus*, *Penicillium*, *Claviceps*, *Fusarium* and *Alternaria* are the five toxinogenic species of microscopic fungi that mainly synthesize mycotoxins.

International Agency for Research on Cancer (IARC) has classified mycotoxins into four groups according to their level of carcinogenicity like group 1 (aflatoxins) carcinogenic to humans; group 2 (AFM1, griseofulvin, Ochratoxin A, sterigmatocystin, Fumonisin B1, B2 and C) possible carcinogenic to humans; group 3 (Penicillic acid, citrinine, Cyclochlorotine, Luteoskyrin, Patulin, Rugulosin, Zearalenone, deoxynivalenol, nivalenol, Fusarenone, Toxin T-2) cannot be classified in terms of its carcinogenicity to humans and group 4 probably not carcinogenic to humans (Brochard and Bâcle, 2009). As a reminder, certain moulds are beneficial and used in the agro-food and biotechnology industries, involved in the production of organic acids, enzymes and pigments (Compaoré *et al.*, 2017). This is the case of *Aspergillus Niger* used for the synthesis of food acids (citric acid and gluconic acid), the production of enzymes (alpha-amylase, lipase, pectinase). Figure 3 show some mycotoxins found in food.

4.3. Toxinogenesis Conditions of Mycotoxins

The environmental conditions necessary for the production of mycotoxins are narrower than those allowing fungal growth and are, in most cases, close to optimal conditions for the development of the species under consideration (Tabuc, 2007). Magan and Aldred (2005) state that in the food chain, some "time-related" factors play an important role in the production of mycotoxins when handling agricultural products before and after harvest. These are intrinsic factors such as moisture content, water activity, substrate type, plant type and nutrient composition; extrinsic factors including climate, temperature, oxygen level; processing factors such as drying, mixing and addition of preservatives, grain handling and implicit factors like insect interactions, the fungal strain, the microbiological ecosystem (Magan and Aldred, 2005). So, the toxinogenesis conditions are water activity (Aw), pH, presence of oxygen, temperature, substrate composition, microbial interaction (Tabuc, 2007) acidity, maturity of the colony mould and carbon dioxide (Brochard and Bâcle, 2009). Most moulds grow well for water activities close to 0.85 (Tabuc, 2007). Also, the water activity required for toxinogenesis is greater than that for fungal growth.

In general, hyphal growth of fungi is optimal between 20 and 25 °C, but often low at 5°C and 35 °C. Some species (Conidia) do not germinate below 5 °C but remain viable for a long time, and temperatures below -20 °C do not kill them. Other harmful moulds including *Penicillium expansum*, *Penicillium verrucosum*, and *Penicillium viridicatum* are psychrotrophic and can develop slowly at temperatures below 4 °C (Guezlane-Tebibel *et al.*, 2016). According to these authors, most fungi normally develop at pH between 3 and 8, their optimum growth being generally obtained for pH between 5 and 6. With regard to the activity of water (AW), mould growth ranges from 0.70 to 0.99. Water activities below 0.60 are not compatible with fungal growth but do not kill Conidia (Guezlane-Tebibel *et al.*, 2016). The production of mycotoxins is more sensitive to the variation of air composition than fungal growth. An oxygen concentration of less than 1% and high concentrations of CO₂ prevent the development of mycotoxins (Keller *et al.*, 1997; Cairns-Fuller *et al.*, 2005). The optimum temperature for the production of mycotoxins is generally close to the optimum growth temperature, but is usually slightly lower (Tabuc, 2007). The qualitative and quantitative composition of nutrients (mainly carbohydrates) can influence the production of mycotoxins. The presence of certain molecules in the substrate can also influence the production of mycotoxins.

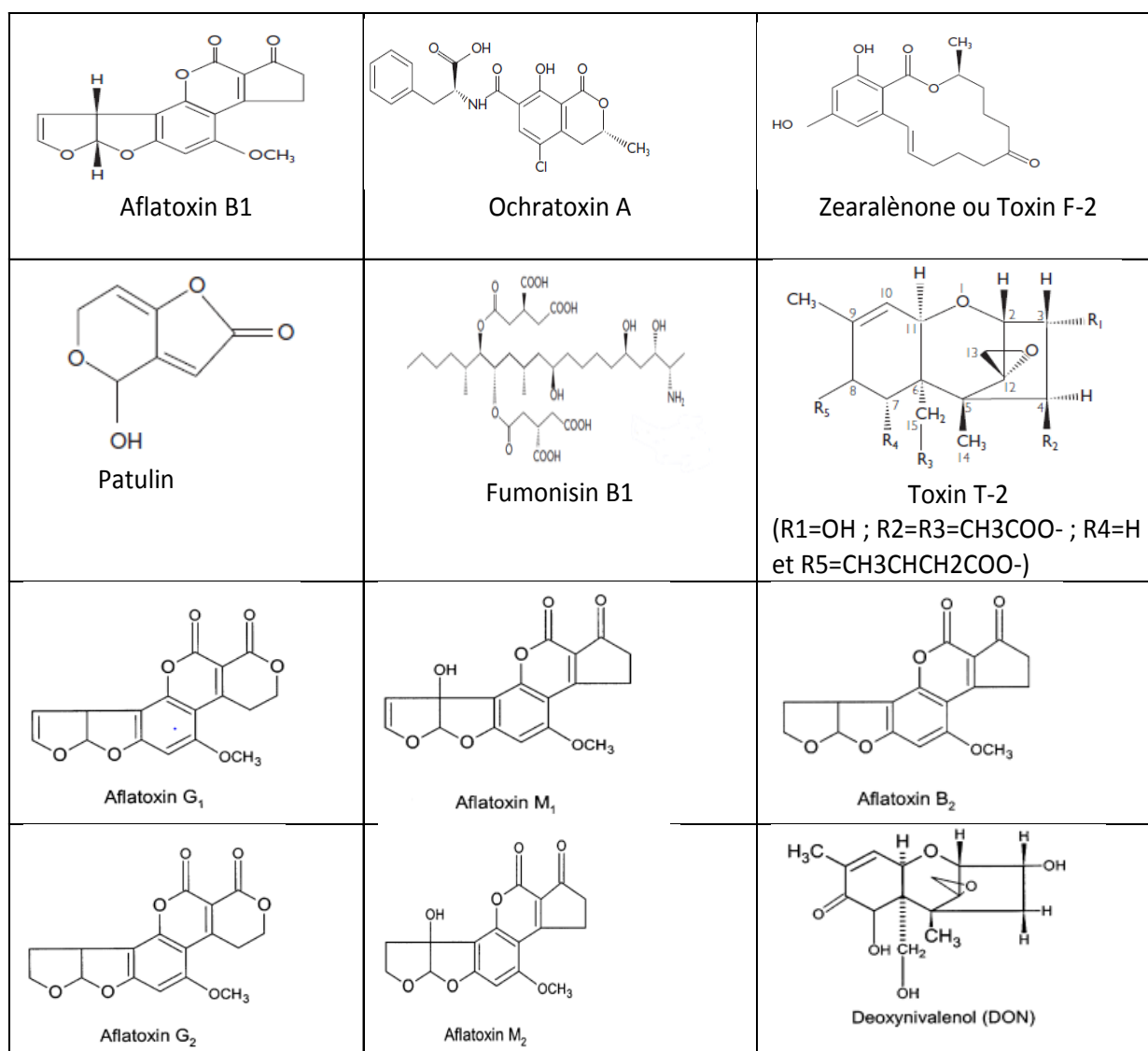

Figure-3. Structures of some mycotoxins.

Source: Brochard and Bâcle (2009); Zain (2011).

The simultaneous presence of several species of microorganisms in the same medium results in a decrease in the production of mycotoxins by each of the microorganisms producing. The growth conditions of each species are specific in terms of physicochemical conditions (Reboux, 2006).

Table-1. Main mycotoxins and producing moulds found in human and/or animal food.

Mycotoxins	Producing mushrooms	Foodstuffs
Aflatoxins (B1, B2, G1, G2)	A. flavus, A. parasiticus, A. nomius, A. bombycis, A. pseudotamarii, A. ochraceoroseus	Peanuts, cereals, cottonseeds, spices, fruits, etc.
Ochratoxins (A, B, C)	A. ochraceus, A. westerdijkiae, A. carbonarius, A. niger, P. viridicatum, P. verrucosum, P. nordicum	Vegetables, cereals and coffee beans, cheeses, fish, meats, etc.
Zearalenone	F. graminearum, F. sporotrichoides	Maize, wheat, barley, etc.
Fumonisin trichothecenes	F. moniliforme	Maize and other grains
Patulin	Fusarium spp.	Maize and wheat.
Citrinin	Aspergillus spp.; Penicillium spp.	Fruits (apples, plums, peaches, pears, apricots).
	P. rubrum, P. purpurogenum, P. viridicatum, P. citrinum A. ochraceoroseus.	Barley, wheat, rice, soy and rye.

Legend: A: Aspergillus, F: Fusarium, P: Penicillium
Source: Bennett and Klich (2003).

Thompson and Henke (2000) noted that tropical and subtropical crops are more sensitive to mycotoxin contamination than temperate ones, as humidity and high temperatures in tropical areas provide optimal conditions for training toxins. In addition, it has been reported that drought can stress plants and make them vulnerable to *Aspergillus* spp (Holbrook *et al.*, 2004; Robertson, 2005). The Table 1 gives some mycotoxins, producing fungi and contaminated foods.

4.4. Mycotoxins in Edible Oils

Vegetable oils are made from agricultural products such as fruits and seeds, by mechanical pressure or by extraction with organic solvents. They play an important role in our daily lives because they provide energy, nutritional components and pleasant aromas (Frankel, 1989; Silva *et al.*, 2010; Cubero-Leon *et al.*, 2014). Currently, soybeans, rapeseed, sunflower seeds, peanuts and olives are the main raw materials for the production of cooking oils in the world. During the growth process, these agricultural products are easily contaminated by mycotoxins due to the constant evolution of environmental conditions and temperature. For example, high temperatures, heavy rainfall and relative humidity are highly conducive to fungal growth and mycotoxin production (Fink-Gremmels, 2008; Mahmoudi and Norian, 2015; Bahrami *et al.*, 2016). Fanelli and Fabbri (1989) demonstrated the key role of lipids on fungal growth and lipid oxidation, which also has an effect on Aflatoxin biosynthesis. Seed surface lipids are a very important source of carbon for fungal growth (Jayashree and Subramanyam, 2000).

According to the International Agency for Research on Cancer (1993) some oilseeds, such as olives, peanuts and sesame, have been found to be contaminated by mycotoxins (mould-producing toxins) known as aflatoxins AF1, AFB1, AFB2, AFG1 and AFG2. Aflatoxins can be retained in unrefined oils. In fact, unrefined oils contain aflatoxins (Bao *et al.*, 2010). The presence of mycotoxins has been reported in several vegetable oils around the world (Samarajeewa *et al.*, 1983; Bordin *et al.*, 2014). Aflatoxins have been reported in olive oils in Greece by Papachristou and Markaki (2004) and in Spain and Morocco by Cavaliere *et al.* (2007) elsewhere in North Africa, in peanut oil in Senegal and China by Bao *et al.* (2010) and in mustard oil, used for cooking in Northern India at concentrations of 55 to 87 ppb (Sahay and Prasad, 1990). The presence of aflatoxins in peanut oils is worrying. According to Abalaka and Elegbede (1982) only 10 to 20% of aflatoxins are transferred from peanut seeds and cottonseed to crude oil. The highest concentration was found in crude peanut oil in Nigeria at 26.1 mg/kg. Tantaoui-Elaraki and Le Tutour (1985) reported that olive oil could be contaminated with other mycotoxins such as ochratoxin A.

Specifically, concentrations of mycotoxins in peanut oil greater than 10 mg/kg, were determined in studies conducted in Nigeria, Nepal, Senegal, China, India and Egypt (Abalaka, 1984; He *et al.*, 2017). In some areas of Senegal, over 85% of the peanuts, oil samples were contaminated with AFB1 at an average level of 40 µg/kg (Abalaka, 1984). Other edible oils, such as chili oil, coconut oil and cottonseed oil, have been reported to be contaminated with AFB1 in England, Sri Lanka (Bao *et al.*, 2010) and Nigeria (Abalaka, 1984) respectively. Elzupir *et al.* (2010) reported levels of aflatoxins in vegetable oils in Khartoum State, Sudan. Contamination was found in 98.8% of the oil samples, with total Aflatoxins (AFB1 + AFB2 + AFG1 + AFG2) levels of 0.43 to 339.9 µg/kg and an average level of 57.5 µg/kg. They found that all sesame oils had much higher aflatoxin levels. The percentage of samples with total aflatoxin values below 20 µg/kg of some oils varied and were 57.14% in peanut oil, 36.8% in sunflower oil. Also, mycotoxins (Aflatoxins) were identified and quantified in sesame oils (0.2-0.8 µg/kg) and 0.6 µg/kg in Sudanese food peanut oil (Idris *et al.*, 2010).

In recent years, the presence of aflatoxins, zearalenone, ochratoxin A, deoxynivalenol and other mycotoxins in vegetable oils has been reported worldwide (Afzali *et al.*, 2012; Escobar *et al.*, 2013). High temperature, high precipitation and relative humidity are highly favorable for fungal growth and mycotoxin production (Fink-Gremmels, 2008; Mahmoudi and Norian, 2015; Bahrami *et al.*, 2016).

4.5. Mycotoxins Action Mode and Health Impact

Moulds can lead to three types of disorders as the alteration of the organoleptic and nutritive qualities of foods leading to a decrease in performance, the appearance of various conditions related to the presence of some fungal strains and acute or chronic intoxications related to the synthesis of toxins (mycotoxins) by some fungal species, mycotoxicoses (Guerre, 1998). As a reminder, a substance is responsible for a mycotoxicosis in humans, when the following five conditions are fulfilled like the existence of the mycotoxin in the diet, the exposure of man to this mycotoxin, the correlation between the exposure and incidence of disease, reproducibility of characteristic symptoms in animals, and similar mode of action in humans and animals (Tozlovanu, 2008).

Mycotoxins are produced in four different processes (Yiannikouris and Jouany, 2002) as the fungal secondary metabolism, the bioconversion of plant compounds, the plant's reaction to aggression and the plant-fungi association. According to Tozlovanu (2008) toxigenic fungi are classified into four groups depending on when they develop such as pathogens for the plant, fungi growing and producing mycotoxins on senescent or stressed plants, fungi originally colonizing plant and predisposing it to contamination by mycotoxin during harvesting, and fungi existing in the soil and in the putrefactive material and which will proliferate during storage. In terms of properties, mycotoxins are compounds of variable structure, aliphatic or polycyclic, aromatic or not. They are neutral, acidic or basic, but almost always water-soluble and predominantly lipid-soluble (Marasas *et al.*, 1988). Their structural diversity is reflected in a wide variety of mechanisms of action and acute and especially chronic toxic effects on animal and human health (Sweeney and Dobson, 1998). In addition to these effects, mycotoxins cause significant economic losses for countries. Mycotoxins are found in many plant foods as natural contaminants. This is the case of cereals, fruits, nuts, almonds, seeds, fodder as well as compound or manufactured foods derived from these raw materials and intended for human or animal consumption (Huybrechts *et al.*, 2013). As a result, products such as eggs, milk, offal (kidneys, liver) from previously exposed animals are also contaminated with mycotoxins (Huybrechts *et al.*, 2013). For example, the crops often affected by *Aspergillus* spp (Aflatoxin) are cereals, oilseeds (soybean, peanut, sunflower and cotton), spices and oleaginous nuts (pistachio, almond, walnut, coconut, walnuts of Brazil). Lipids play a key role in growth, especially aflatoxins (Fanelli and Fabbri, 1989).

Mycotoxin metabolites are toxic and carcinogenic, immunosuppressive, hepatotoxic or neurotoxic (Engel *et al.*, 2014). They pose a real public health problem in Africa. African populations are exposed to aflatoxin even before birth (Williams *et al.*, 2004; Wild and Gong, 2010). The harmful effects of toxins are diverse. Some toxins exert a hepatotoxic power (aflatoxins), others are estrogenic (zearalenone), immuno/haematotoxic (patulin, trichothecenes, fumonisins), dermonecrosis (trichothecenes), nephrotoxic (ochratoxin A) or neurotoxic (tremorgenic toxins) (AFSSA, 2009). More specifically, aflatoxins have been classified in group 1 as carcinogenic to humans because of their role in the etiology of liver cancer, ochratoxins in hepatomegaly, enteritidis and lymphoma (Creppy *et al.*, 1983; Anon, 1989; Kuiper-Goodman and Scott, 1989; Heussner and Bingle, 2015). Abrunhosa *et al.* (2016) reported that zearalenone and fumonisins interfere with mammalian reproductive function and cause immunosuppression. The toxicity may not come from the mycotoxin itself, but may be due to one of its metabolites resulting from its degradation (Gauthier, 2016). In animals, fodder invaded by moulds and mycotoxins causes various diseases of livestock including ergotism, tetany due to paspalum, tetany due to ryegrass, facial eczema, fescue foot, lupinosis, drool syndrome and stachybotryotoxicosis (Lacey, 1991).

In the agricultural sector, FAO estimates that more than 25% of all agricultural products are contaminated with mycotoxins (Marin *et al.*, 2013). This is a huge economic loss for the countries. The synthesis of fungal toxins and fungal growth are conditioned by various physical, chemical and biological factors (D'Mello *et al.*, 1997). Thus, the nature of the substrate, the water content, the temperature and the gaseous composition will determine the fungal capacity to grow and to produce toxin (Guerre, 1998). A mycotoxin can be produced by different moulds and one strain can produce several different toxins, depending on climatic conditions (Richard *et al.*, 2003). The toxicity may not necessarily come from the mycotoxin but one of its metabolites resulting from its degradation. The

synthesis of mycotoxins is influenced by the environmental parameters but also by the growth of a specific mould. As a result, the identification of a species of mould on a substrate does not make it possible to predict with certainty the presence of a mycotoxin in this substrate (Gauthier, 2016).

4.6. Regulatory Limit and Removal Methods of Mycotoxins

The fight against mycotoxins can be at two levels like institutional and scientific. A large number of countries including 15 African countries have legislated on some mycotoxins including aflatoxins (Fellinger, 2006; Njobeh *et al.*, 2010). It should be noted that regulations on mycotoxin levels in foods vary from country to country. In Africa, the maximum tolerable levels for aflatoxins in food for human consumption in general is range from 5 to 20 ppb compared to 5 up 300 ppb for animal feed and 0 to 10 ppb for infant food (Fellinger, 2006; Njobeh *et al.*, 2010). In terms of regulation, most countries in the Economic Community of West African States (ECOWAS) zone use food codex limits or those established by commercial partners (Dieme *et al.*, 2016). Maximum limits not to be exceeded are set for products intended for human and animal consumption in order to guarantee their health. For example, maximum limits not to be exceeded are for peanuts, nuts, dried fruits and products derived from their processing, intended for direct human consumption or for use as food ingredients of 2 µg/kg for AFB₁; 4µg/kg for B₁, B₂, G₁ + G₂ and 400 µg/kg for zearalenone in corn oil (CEC, 2006). There is no universal method that is suitable for treating all mycotoxins. Preservation processes (sterilization, pasteurization, lyophilization, freezing, etc.) do not destroy or destroy a few mycotoxins (Harris and Staples, 1992). According to Peers and Linsell (1975) aflatoxins remain stable in peanuts or maize after heating at 200 °C for 30 min.

However, decontamination methods for moulds and mycotoxins can be divided into physical, chemical and biological methods (Hadjeba-Medjdoub, 2012). Physical detoxification methods include washing, drying, sorting, separation of dust, hulls or skins which are the essential place of contamination (Yiannikouris and Jouany, 2002) wet moulding, cooking extrusion, thermal deactivation and irradiation (Hadjeba-Medjdoub, 2012). Chemical methods include the treatment with ammonia under pressure, addition of propionate, or any other mould inhibitor (Yiannikouris and Jouany, 2002) leaf extract of *Lippia multiflora* (Anjorin *et al.*, 2008) butylated hydroxyanisole (BHA), butylated hydroxytoluene (BHT) and propyl paraben (PP) (Chulze, 2010) extracts from neem (*Azadirachta indica*) and scopoletin (Dieme *et al.*, 2016) essential oils (Chulze, 2010). The biological methods consist in the addition of some bacteria that are able of binding and de-toxifying mycotoxins (Oatley *et al.*, 2000; Pierides *et al.*, 2000). This is the case of yeasts and lactic acid bacteria (Hadjeba-Medjdoub, 2012). Thus, the combination of several treatments enhances the efficiency of each process but does not allow the total decontamination of the product. The methods must reduce the concentration of toxin or degrade it, without producing toxic degradation residues, or reduce the organoleptic and nutritional qualities of food (Park *et al.*, 1988). Conventional heat treatments of food sterilization can destroy moulds, but are most often ineffective against mycotoxins (thermostable compounds) (Scott, 1998). The ruminal flora or the liver degrade a large part of the mycotoxins. Hence the expression of the toxicity of mycotoxins, most of the time, in a chronic form (Fangeat, 2008).

In particular, aflatoxins are insensitive to most heat treatments (sterilization, pasteurization, freezing) or drying (dehydration, lyophilization), with the exception of roasting (AFSSA, 2009). The process of roasting groundnuts (peanuts) is effective in reducing the initial aflatoxin content by 50 to 80%. During the oil extraction process, the aflatoxins B and G are mainly found in cakes (soya cake, peanut, cotton, etc.) and in the crude oil in minor quantities. Subsequent oil refining processes remove traces of aflatoxins (AFSSA, 2009). Curative methods can be used for the decontamination of mycotoxins present in edible oils. This is the case the use of solar radiation, well adapted to the homemade peanut oil packaged in clear glass bottles in the case of aflatoxin which becomes undetectable after two days of exposure to the sun, without altering the physicochemical parameters (Martin *et al.*, 1999). Decontamination is due to solar radiation and not only to temperature rise, because below 100°C the aflatoxins are very stable to heat. Also, the addition to the oil of clays such as bentonite or attapulgite are likely to

strongly complex aflatoxin (Martin *et al.*, 1999). In general, the removal of contaminants can be eliminated in the neutralization step. But it is above all the stages of discoloration (selective adsorption) and deodorization that minimize the level of contaminants (De Kock *et al.*, 2005). As a result, the removal of mycotoxins from the oils is done during the refining steps. This is the case of aflatoxins which are eliminated during the steps of a conventional chemical refining under the action of sodium hydroxide during the neutralization with a reduction of 90 to 98%. The residue is removed at the discoloration stage. The deodorization stage which is carried out at high temperature (180/240 °C) and under a very high vacuum by steam distillation the mycotoxins present in the oils (Itegr, 2019).

In general, refining based on alkaline neutralization, washing, bleaching, and deodorization has been reported to be able to remove mycotoxins from oils (Kamimura *et al.*, 1986). In clear, organic solvents (chloroform, acetone, hexane and methanol) were used to extract aflatoxins in agricultural products, but mainly in the process of refining vegetable oils. Treatment with sodium hydroxide significantly reduced AFB1 and AFB2, deoxynivalenol and nivalenol remained in trace, AFG1 and AFG2 were completely eliminated (Kamimura *et al.*, 1986). An assertion had previously been confirmed by Parker and Melnick (1966) that sodium hydroxide effectively removed aflatoxins from peanut oil. According to Slope *et al.* (2013) zearalenone (ZEN) is removed below a level of concern in corn germ oil by alkaline treatment at pH 9-10. Bleaching has reduced aflatoxin levels in peanut and corn oils below 1 µg/L (Parker and Melnick, 1966) trichothecenes and aflatoxins but not ZEN (Kamimura *et al.*, 1986). Deodorization at high temperature (220-270 °C) and at low pressure (0.1-0.7 kPa) can lead to the complete elimination of aflatoxins from vegetable oils. Trichothecene and ZEN levels have also been reduced (Kamimura *et al.*, 1986). Apart from detoxification methods, the reduction of the impact of food poisoning also involves controlling all stages of processing, conservation, consumption and compliance with hygiene rules (Gauthier, 2016).

4.7. Analytical Methods of Mycotoxins

There is a variety of quantification methods categorized into two groups. Rapid screening methods such as immunological methods and thin layer chromatography (TLC), and quantitative methods such as liquid or gas chromatography (HPLC and GC). Their quantification requires a preliminary extraction and even purification step (Huybrechts *et al.*, 2013). Several methods are used to detect mycotoxins in food, thin layer chromatography (TLC), immunosorbent test enzyme linked (ELISA), capillary electrophoresis (CE), high performance liquid chromatography (HPLC) and liquid chromatography-tandem mass spectrometry (LC-MS/MS) are practical methods for the detection and analysis of aflatoxins. HPLC and LC-MS/MS as an advanced technique are commonly used.

The LC-MS/MS developed method is selective and accurate but is not as sensitive as HPLC coupled with fluorescence detection (FLD) (Nabizadeh *et al.*, 2015). Also, the HPLC can be coupled with UV, diode array detector (DAD) or MS detection and gas chromatography (GC) coupled with electron capture detector (ECD), flame ionization detector (FID) or MS detection (Alshannaq and Yu, 2017). With regard to emerging immunochemical technologies, "lateral flow devices (LFDs)" allow rapid detection of mycotoxins, the enzyme-linked immuno filtration assay (ELIFA) test is a disposable (after use) tool based on the use of a membrane, the fluorescent polarization immunoassay (FPIA) immunoassay procedure, the immunochemical bio-detectors that use surface plasmon resonance (plasmon resonance surface [SPR]) or surface biosensors of carbon electrodes (screen-printed carbon electrodes), the enzyme-linked aptamer assays (ELAA) (Huybrechts *et al.*, 2013).

Liquid chromatography coupled with a mass spectrometer (LC-MS and above all LC-MS/MS) is increasingly used to quantify several mycotoxins or related metabolites (Razzazi-Fazeli *et al.*, 2002; Spanjer *et al.*, 2008; Monbaliu *et al.*, 2010) or the determination of masked mycotoxins (deoxynivalenol-glucoside) or conjugated to more polar substances (glucuronic acid) (Zöllner and Mayer-Helm, 2006; Berthiller *et al.*, 2009). The application of infrared spectroscopy (Fourier transform mid-infrared spectroscopy (FT-MIRS)) and near infrared transmittance (NIT) are a method of detecting the presence of deoxynivalenol as an alternative to the use of SPE, micro-

extraction in solid phase (solid phase micro-extraction) (SPME) is reported as well as extraction by two-phase dialysis (Huybrechts *et al.*, 2013).

The main components of vegetable oils are lipids containing a high percentage of Monounsaturated and saturated fatty acids and pigments (Moreno-González *et al.*, 2014) which are difficult to clean. The choice of an appropriate absorbent is very important for an effective cleaning method to reduce the effects of matrix and Interference during chromatographic analysis. More recently, the method combining the QuEChERS extraction and universal cleaning method (Quick, Easy, Cheap, Efficient, Rugged and Safe) with HPLC-MS/MS is used for the determination of mycotoxins in edible oils (Zhao *et al.*, 2017).

5. PESTICIDES

5.1. Origin and Definition of Pesticides

The word pesticide comes from the association of the English word pest (animal, insect or pest), which comes from the Latin pestis (plague, calamity) and the suffix cide (Latin cida, the Latin verb caedo, caedere, "kill") (Couteux and Salaün, 2009). A pesticide is a substance or mixture of substances used to prevent the action, destruction or neutralization of a pest, a vector of human or animal disease, a plant or animal species that is harmful or troublesome during the production, processing, storage, transport or marketing of foodstuffs, agricultural products, wood and wood products, or animal feed, or may be administered to animals to destroy insects, arachnids or other parasites on the surface of their bodies or inside their bodies (FAO, 1986).

Fertilizers, plant and animal nutrients, food additives and veterinary products are excluded (WHO, 1991). The advent of pesticides has been an important development. It is in ancient Greco-Roman that the use of mineral products could rise. Several pesticides were used. This is the case of the obvious interest of sulfur as a disinfectant and arsenic as an insecticide and the use of soda and olive oil for the treatment of legume seeds; followed nicotine in the form of extracting tobacco. Pyrethrum and soap were used in the nineteenth century against insects; while a combination of tobacco, sulfur and whitewash is developed to combat insects and fungi. In 1986, the Bordeaux broth (copper sulphate and calcium hydroxide) proved the destruction of adventitious plants using chemicals.

In 1913, the first organo-mercury coated seeds were introduced in Germany. Between the two world wars, phytosanitary products have evolved including the use of tar oil against flea eggs, in 1932 the dinitro-orthocresol against weeds in France, in 1934 the thiram as the fungicides to USA. Other pesticides were introduced during the Second World War. This is the case for DTT in Switzerland, organophosphates in Germany, herbicides derived from phenoxyalocanoid acids and carbamates (herbicides) in the United Kingdom. Between 1950-1955, herbicides derived from urea appeared, captan and glyodine (fungicide) and Malathion. From 1955 to 1960, trazines and quaternary ammoniums were used as herbicides, while from 1960 to 1965 dichlo-benil, trifluralin and bromoxynil were used. Benomyl, an endotherapeutic fungicide, appears in 1968 (Hassall, 1982).

The second generation of pesticides characterized by a reduction of the doses used and a better efficiency happens during the period 1970-1980 in particular the photostable pyrethroids (deltamethrin) for the insecticides and the sulfonyl ureas (chlorsulfuron) for the herbicides, the family of the phosphonates, case glyphosate (Roundup a very famous herbicide acting on the leaves).

The third generation of pesticides started in 1980 based on bio-rational research makes it possible to obtain new more effective active substances with a reduction of applied doses, more selective of the target organisms, thus causing less risk for non-target organisms and thus ensuring a better respect of the environment (Fillatre, 2011).

The term pesticide (phytosanitary product in current use) designates phytosanitary products (phytopharmaceutic when they are accompanied by an adjuvant) intended to protect the plants against all organisms harmful substances and biocides which are, in a broad way, intended to destroy, repel or render harmless harmful organisms (Camard and Magdelaine, 2001). According to Directive 98/8/EC biocides, or pesticides for non-agricultural use, include antiparasitics and disinfectants, used in human hygiene, veterinary and for premises

and mat Eriel, as well as algicides, fungicides and all protection products against pests of materials and habitats (Bouvier, 2005). In a simplified way, pesticides refer to all substances that are active or used for the prevention, control or elimination of organisms considered to be undesirable, be they plants, pests or fungi (Fillatre, 2011). The effectiveness of a pesticide depends on its active substance. It can be defined as "substances or micro-organisms, including viruses, which have a general or specific action on pests or on plants, plant parts or plant products" (Catherine, 2014). For their application, governed by strict conditions incorporated in good cultural practices, the active substances are generally formulated with carriers or correctors (solvents, emulsifiers, wetting or spreading agents, agglutinating agents or adhesives and odoriferous agents) (Pages *et al.*, 2010). Other adjuvants are synergists, coloring agents, dispersing agents and carrier substances. The active ingredient cannot be used alone, it also requires diluent ingredients or adjuvants to make it suitable for practical and effective use (Boland *et al.*, 2004). In the end, to act, the active substances must reach their target which may be located on the surface or inside the target organism. Hence contact pesticides act on the surface and systemic pesticides act after transfer to the interior of the plant and diffusion through the sap (Fillatre, 2011).

5.2. Pesticides Typology

Pesticides commonly include plant protection products that are a combination of substances used to control plants diseases, animal pests (insects), weeds ("weeds" that colonize crops) and biocides, products used to protect domestic animals or building elements (framework) (Camard and Magdelaine, 2001). Pesticides are a very diverse group of chemicals from more than 100 different chemical classes (Roszko *et al.*, 2012). It is estimated that more than 1,000 active substances are or were in the past used for the protection of crop plants (Tomlin, 2003). Pesticides are found in formulations like dry or solid formulations (dusting powders, granules, wettable powders, water-soluble powders, water-soluble granules, water-dispersible granules and pesticide baits), liquid or wet formulations (concentrated solutions, emulsifiable concentrates, liquids for very low volume application), and other types of formulations, some fumigants, fumes, gases or vapors (Boland *et al.*, 2004).

The classification of pesticides is mainly based on the chemical nature, the use (agriculture, public health, domestic) and the organism or the target (insecticide, herbicide, fungicide) (Jayaraj *et al.*, 2016). The chemical classification concerns inorganic pesticides (sulfur, copper) which are very old and of which there are no more inorganic insecticides but a single herbicide, the sodium chlorate still used. Most of these pesticides are fungicides (Bordeaux mixture) organometallic pesticides which are fungicides (mancozeb and maneb) and organic pesticides (organochlorines, organophosphates). Biological or target classification including three major classes of pesticides representing 90% of plant protection products. These are insecticides (pests), herbicides (crop weeds), and fungicides (pests and pathogenic fungi). Other minor classes correspond to active substances intended to combat specific targets as acaricides (mites), nematocides (nematodes), corvids (pest birds), rodenticides (rodents), molluscicides (slugs and snails), taupicides and corvifuges (Fillatre, 2011). Classification according to use includes crops, livestock buildings, plant material storage areas, non-agricultural areas, residential buildings, and humans and animals. The main families of active substances (organochlorine compounds, organophosphorus compounds, carbamates and thiocarbamates, pyrethrins and pyrethroids, triazines and fumigants) are used in the different classes of pesticides. Most pesticides currently used are organic in nature, a small number of which are extracted or derived from plants (LNE, 2008). In terms of persistence, organophosphorus pesticides are less persistent than organochlorines worldwide because they do not bioaccumulate or biomagnify, and do not release toxic degradation products (Krieger, 2001). These characteristics justify their application in the agricultural and veterinary practices of the modern world. Depending on the chemical nature of the pesticides, there are Organochlorines; Organophosphates; Carbamates; pyrethroids; Phenylamides; Phenoxyalkonates; the triazines; benzoic acids, phthalimides (Jayaraj *et al.*, 2016). There are currently more than 80 families or chemical classes, the main ones being amines, carboxylic acids, carbamates, thiocarbamates, diphenyl ethers, nitrogenous heterocyclic

(triazine, pyrimidine, bipyridinium), azoles, organophosphorus compounds, pyrethrinoids, substituted ureas, sulfonylureas and uracils. The Figure 4 indicates the main chemical families of pesticides identified by the presence of functional grouping, of particular atoms or secondary groups of atoms (Diop, 2013). Organophosphorus (OP) pesticides are synthetic esters, amides, or thiol derivatives of phosphoric, phosphonic, phosphorothioic, or phosphonothioic acids (Hassall, 1982; Corbett *et al.*, 1984; Quin, 2000). The structural diversity of this family of compounds is reflected in their physicochemical and biological properties like vapor pressure, solubility in water, chemical stability, and toxicity (Hassall, 1982; Corbett *et al.*, 1984) which determine their specific application (Hassall, 1982). While organochlorine pesticides are complex synthesis compounds, their basic structures are cyclic or polycyclic, substituted by one or more chlorine functions. This family groups together numerous molecules grouped in 5 families (Mazet, 2005) like dichlorodiphenyltrichloroethanes (DDT, DDE, DDD and metho-xychlor); hexachlorocyclohexanes (lindane); cyclodienes (aldrin, dieldrin, and endosulfan); toxaphene and structures such as chlordecone and mirex. They are persistent organic pollutants or POPs (De Kock *et al.*, 2005). Chemical phytosanitary products have many advantages. However, their use can be the cause of environmental problems and public health (Deravel *et al.*, 2013). This allowed the use of phytosanitary products of biological origin, biopesticides. Biopesticides are classified into three broad categories, according to their nature like microbial biopesticides, plant biopesticides and animal biopesticides (Chandler *et al.*, 2011; Leng *et al.*, 2011).

5.3. Toxicity of Pesticides

The toxicity of pesticides is twofold like acute toxicity and chronic toxicity. The statistical estimate of the dose of a chemical compound needed to kill 50% of a laboratory animal population is called the DL50 (the lethal dose for 50%). The DL50 is expressed as mg of active ingredient per kg of body weight of the test animal. This is the term used for acute toxicity (Boland *et al.*, 2004). We distinguish between oral DL50, cutaneous DL50 and inhalation DL50. Chronic toxicity is assessed from experimental chronic animal health data required in the registration file. The labeling incorporates these criteria by the symbols T (toxic), T + (very toxic), Xn (harmful), Xi (irritant) and risk phrases R40 to R43, R45 to R49 and R60 to R64. Risk phrases exist for carcinogenic (R45, R49 and R40), mutagenic (R46 and R68), reprotoxic (R60 and R62) and teratogenic (R61 and R63) substances. These risk phrases refer to the classification of CMR compounds (Carcinogenic, Mutagenic and Reprotoxic) into three categories where x is either carcinogenic, mutagenic, Reprotoxic or teratogenic (Fillatre, 2011).

The different classes of pesticides are "Ia" (Extremely Hazardous), "Ib" (Very Hazardous), "II" (Moderately Hazardous), "III" (Low Hazard) and "U" (Safe in a normal use) (Boland *et al.*, 2004). Their widespread use in agriculture causes the inevitable presence of residues in food (Roszko *et al.*, 2012). The World Health Organization (WHO) has classified active ingredients according to their oral toxicity (taken by mouth) and their skin toxicity (through skin contact) (Boland *et al.*, 2004). According to the National Cancer Institute (2014) any pesticide has a more or less toxic potential for other organisms that it does not target. Thus, the man is concerned, and first and foremost the users of pesticides in a professional level.

Exposure to pesticides can have both short and long-term effects. The delayed effects of pesticides on human health may be the consequence of past exposure, which is generally intense (acute exposure), or lower intensity exposures but repeated over time (chronic exposures, cumulative exposures to multiple substances, multi-path exposures) (NCI, 2014). Exposure is direct or indirect contact with a pesticide and may affect humans or animals. The degree of exposure is determined by the concentration of the toxic active ingredient, the area of skin exposed, the sensitivity of the organism, the duration of contact and the frequency of repeated contact. These pooled elements determine the risk of poisoning (Boland *et al.*, 2004).



<p>Organochorin</p>  <p>Dichlorodiphenylethane ou DDT</p>	<p>Organophosphorous</p>  <p>Malathion</p>	<p>Carbamate</p>  <p>carbofuran</p>
<p>Pyrethronoides</p>  <p>λ cyhalothrin</p>	<p>carboxylic Acid</p>  <p>(2,4-dichlorophenoxy) acetic acid</p>	<p>Amine</p>  <p>Trifluralin</p>
<p>Nitrogen heterocycle (Triazines)</p>  <p>Atrazine</p>	<p>Nitrogen heterocycle (Bipyridinium)</p>  <p>Paraquat</p>	<p>Azoles</p>  <p>Tetraconazole</p>
<p>Substituted ureas</p>  <p>Diuron</p>	<p>Uraciles</p>  <p>Bromacil</p>	<p>Diphenyl ether</p>  <p>Aclonifen</p>

Figure-4. Structures of pesticides.

Source: Diop (2013).

For many pesticides, there is a limit value of the residual amount of pesticide that is allowed to be on the product. This limit value is referred to as the Maximum Residue Limit or MRL (Boland *et al.*, 2004). Maximum

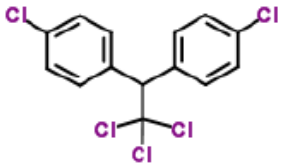
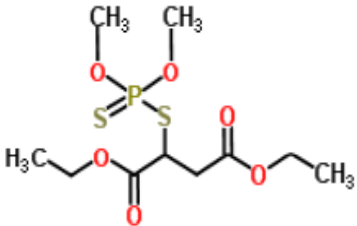
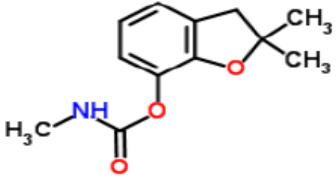
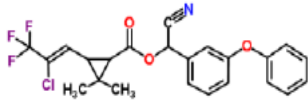
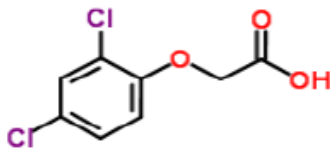
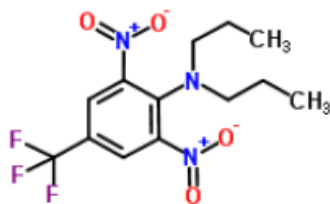
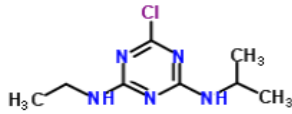
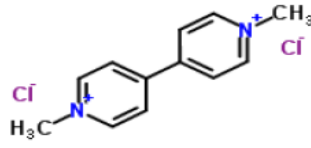
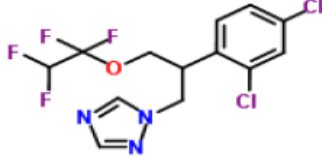
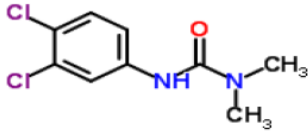
Residual Limits (MRLs), the maximum concentrations of a residue that is legally permitted or considered acceptable in or on a foodstuff, are established by the authorities based on the evaluation of residues found in field trials, based on Good Agricultural Practices (GAP), and applying the principle of minimization or ALARA principle (As Low As Reasonably Achievable as Low As Possible (Benzine, 2006). Clearly, this is the amount left by a pesticide in or on food and includes all pesticide derivatives, namely metabolites and pesticides products reaction (Benzine, 2006). When applied to the plant, the active substance is likely to degrade under the influence of physical factors (temperature, UV radiation, water) or biological (metabolized) (Fillatre, 2011).

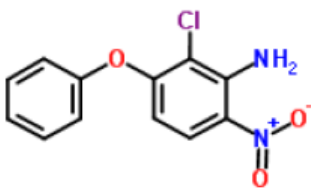
The risks induced by long-term and short-term exposure to pesticide residues in food are assessed through toxicological reference thresholds known as the Admissible Daily Intake (ADI) for long-term exposures (chronic toxicity risk), and the Acute Reference Dose for short-term exposures (acute toxicity risk) (ArfD) to pesticides (Benzine, 2006). ADI is defined as a safety threshold and represents the amount of product that may be safe for human consumption. ArfD is the highest amount of pesticides that can be absorbed in a day by humans without any damage.

5.4. Pesticides in Edible Oils

Pesticides are present in oilseeds and edible oils. Several studies have reported that some commercially available oils and oilseeds are contaminated by pesticides (Thakare *et al.*, 1969; Srivastava *et al.*, 1983; Dikshith *et al.*, 1989) especially pyrimiphos-methyl molecules, dichlorvos and malathion (organophosphorus insecticides used in storage) were the three most frequently detected molecules in seeds (20 to 30% of cases) and in crude oils (70 to 80% of cases) (Lacoste *et al.*, 2005). According to these authors, crude oils contained at least one pesticide residue with a content above the limit of quantification. Also, pesticides have been identified in cold pressure oils (Roszko *et al.*, 2012). Organo-persistent pollutants (POPs) have been identified in edible oils (Roszko *et al.*, 2012). According to Lacoste *et al.* (2005) the health status of crude sunflower and rapeseed oils showed that refining was necessary to remove pesticide residues from crude oils. Indeed, very few samples are free of residue (<0.01 mg/kg). Overall content of pesticide residues is on average between 0.1 and 0.25 mg/kg, with maximum levels order of 1 mg/kg.

Several studies have paid particular attention to the presence of pesticides in various edible oils sometimes with the use of different analytical methods, the modification of existing methods or the optimization of certain methods (Ferrer *et al.*, 2005; Garcia-Reyes *et al.*, 2007; Li *et al.*, 2007; Gerrit, 2008; Van Duijn and Den Dekker, 2010; Sobhanzadeh *et al.*, 2011; Polgár *et al.*, 2012; Roszko *et al.*, 2012; Sharmili *et al.*, 2016; He *et al.*, 2017). The list is not exhaustive. From this fact, it is essential to take into account pesticide residues in the process of refining edible oils. Food oils destined for human consumption must comply with the standards for the said oils.

5.5. Action Mode and Impact on the Health of Pesticides

Pesticides can be found in the human body directly through ingestion, inhalation or skin penetration or indirectly through contaminated soil, dust, water or food (Diop, 2013). Pesticides and insecticides for example, can kill by dermal contact (with the skin), act as a poison in the stomach, inhibit growth or repel the insect (Boland *et al.*, 2004). The highlighting of the particularly dangerous properties of pesticides has led to the release of the authorization on the market and the use of plant protection products that comply with strict legislation (DGAL, 2000). According to WHO (1997) the risk of contaminants to the consumer is the probability of an adverse effect occurring. It is a function of the danger of the substance and the level of exposure of individuals. FAO warned against poor quality pesticides in developing countries. He estimates that 30% of the pesticides marketed in these countries do not comply with the quality standards and threaten human health and the environment.

Also, the modes and the conditions of use are not always mastered by the users who can thus exposing. The widespread use of pesticides contaminates water, soil and air, but also accumulates in crops (fruits and vegetables) (Fenik *et al.*, 2011). Developing countries where personal protection measures are often inadequate or absent are the

most affected, accounting for 99% of deaths due to poisoning (Mawussi, 2008). WHO estimated in 1990 that the number of deaths from pesticide poisoning in the world is 220,000 every year (WHO, 1990). Pesticides pose exotoxicological risks. Phytosanitary products applied in an environmentally unsound manner may have negative impacts on living organisms. Exposure to pesticides can have short and long-term effects (NCI, 2014). Indeed, the manifestation of the effects of pesticides can be immediate or a few hours after intoxication or in the long term may be local or affect the entire body (Diop, 2013). They can harm dangerously to animal and human health. They are mostly lipophilic and accumulate in the tissues of the human body. They may be responsible for dermatological, mutagenic, carcinogenic, teratogenic and neurological effects as well as hormonal disorders (Repetto and Baliga, 1996; Daniels *et al.*, 1997). The link between pesticide exposure and the constant rise in the incidence of certain diseases such as decreased immunity, reproduction, dysfunction in neurocognitive development, congenital anomalies, leukemias, brain tumors and other childhood cancers as well as neurological disorders (Dewailly *et al.*, 2000; Greenlee *et al.*, 2003; Menegaux *et al.*, 2006). The majority of men exposed to pesticides have a sperm concentration well below the limit considered normal for fertile men (Oliva *et al.*, 2001; Velez *et al.*, 2001). Neurological disorders that result in neurodegenerative diseases such as Parkinson and Alzheimer are attributed to pesticide exposure (Baldi *et al.*, 2003). Some lead to urogenital malformations or morphological pseudo-hermaphroditism (Hodgson and Levi, 1996) with deficiencies of the immune system (Vine *et al.*, 2001). In view of the risks that pesticides pose to public health and the balance of the environment, scientific research has turned towards a new generation of pesticides of natural origin (plant extracts). This is the case of extracts of neem whose active ingredient called Azadirachtin A (AZ-A). The products are in the form of emulsifiable solutions, among which mention may be made of Neem-Azal F, Neem-Azal T and Neem-Azal T/S. Moreover, given the damage caused by synthetic pesticides, biopesticides are alternatives to limit the damage caused. The biopesticides of origin (microbial, plant or animal) are less toxic than their chemical counterparts. They can be used as well in conventional agriculture as in organic farming. Some vegetable oils, which have no intrinsic pest control activity, can be found on the market as a bio-pesticide (rapeseed oil) (Deravel *et al.*, 2013).

5.6. Regulatory Limit and Removal Methods of Pesticides

The growing application of pesticides for agricultural purposes has caused significant environmental pollution, and is a threat to health including the risks of oral exposure (food and drinking water). Also, pesticides are persistent (resistance to chemical degradation, photochemical and biological) and accumulate in the environment and in humans through the food chain, causing various pathologies and other physiological disorders often very severe. This has led to more or less harsh regulations restricting their use or outright total prohibition (Mawussi, 2008). As a result, certain regulations are developed for the use of pesticides, particularly with regard to residual levels in foods. Some organizations, such as the Codex Alimentarius, and the European Union such as the regulation CE No. 149/2008 have established maximum residue limits (MRLs) for pesticides.

In Africa the Sahelian Pesticides Committee (CSP) regularly publishes the global list of pesticides for crop protection and biocides (public hygiene) used in Permanent Interstate Committee for Drought Control in the Sahel (CILSS) member countries. This list highlights in particular the target bio-aggressor, the field of use and the class (CSP, 2018). With respect to edible oils, the Codex Alimentarius has established MRLs for unrefined or refined (edible) oils. These MRLs for the processed food may be greater than, equal to or less than the MRL of the corresponding crop product. For example, the MRLs for edible cottonseed oil are for Aldicarb (0.01 mg/kg), Cyhalothrin (0.02 mg/kg), Dicofof (0.5 mg/kg), Dimethipin (0.02 mg/kg), Fenvalerate (0.1 mg/kg), Flucythrinate (0.2 mg/kg), Glyphosate (0.05 mg/kg), Paraquat (0.05 mg/kg) and Profenofos (0.05 mg/kg). For cotton edible oil and unrefined oil, the Phorate content is 0.05 mg / Kg and 15 mg / Kg for Pirimiphos-methyl (Codex, 2003). These MRLs vary from one chemical type of pesticide to whether the oil is refined or not. Thus, refining is a way to remove pesticides from oils. In chemical refining, dichlorvos is completely removed during the neutralization while

a deodorization step carried out at 220 °C is necessary to achieve the same result for Malathion and Fenitrothion, for initial contamination rates in the order of 0.5 mg/kg.

The pyrimiphos methyl is eliminated during the discoloration step. Physical refining provides equivalent results but the deodorization temperature is higher, around 240 °C, there is no residue left at the end of this step. According to Pages *et al.* (2010) the refining of vegetable oils by conventional "physical" or chemical processes eliminates pesticide residues that may be contained in crude oils. In all cases the conditioning steps (phosphoric acid), the alkaline neutralization, the discoloration, deodorization and neutralizing distillation intervene in the pesticides elimination contained in the oils.

5.7. Analytical Methods of Pesticides

In environmental matrices and foodstuffs, analysis of pesticide residues requires highly specific, sensitive and reliable methods such as gas chromatography (GC) and high performance liquid chromatography (HPLC). Their dosage is based on their volatility, polarity and susceptibility to thermal degradation (Mawussi, 2008). The gas chromatograph (GC) is the basic instrument of any laboratory looking for pesticide residues. As for HPLC, it is a complementary technique to gas chromatography. Spectrophotometric detectors equipped with micro-cells have appeared on the market (Benzine, 2006). The pesticide residue analysis technique generally includes sampling of the matrix; the pretreatment of the samples, the extraction of the active substances from the matrix by appropriate organic solvents, the purification which makes it possible to separate the desired molecules from the impurities originating from the matrix, which may interfere during the assay, the instrumental analysis by chromatography gas phase (GC) or high performance liquid phase (HPLC) coupled with specific and sensitive detectors such as mass spectrometry which is a highly selective detection mode (Mawussi, 2008). For the pesticides determination in the carbamates family, thermosensitive compounds, HPLC is the best indicated (Benzine, 2006).

Several techniques of sample preparation for pesticides extraction from vegetable oils, particularly olive oil and even soybean oil prior to chromatographic separation have been developed (Sobhazadeh *et al.*, 2011). The cleaning step, in most cases based on liquid-liquid separation by extraction with solvents of different polarity (Lentza-Rizos *et al.*, 2001) gel permeation chromatography (GC) (Guardia *et al.*, 2006) microwave-assisted extraction (Fuentes *et al.*, 2008) solid phase extraction (SPE) (Chen *et al.*, 2009) matrix solid phase dispersion (MSPD) (Qi, 2010; Sobhazadeh *et al.*, 2011) micro-extraction in the solid phase (Ravelo-Pérez *et al.*, 2008) and QuEChERS extraction method (Hernández-Borges *et al.*, 2009). Moreover, several authors have used chromatographic methods (CPG, HPLC) for the quantification of pesticides in edible oils. QuEChERS extraction method is used a lot because it is very simple, fast and economical. Several details on the techniques used for pesticide analysis, for example the analysis of organophosphorus pesticides, were discussed by Stoytcheva and Zlatev (2011).

6. GOSSYPOL

6.1. Origin and Definition of Gossypol

Gossypol is a yellow pigment in free or bound form in all parts of the plant, the cotton with the highest levels found in seeds (Adams *et al.*, 1960; Markman and Rzhekhin, 1969; Jaroszewski, 1998; Dodou, 2005). Gossypol (C₃₀H₃₀O₈) is a product of the plants metabolism of the genus *Gossypium*, but it is also obtained from the bark of *Thephesia populnea* which, like cotton, is a shrub of the family Malvaceae (Dao, 2002). The name "gossypol" was proposed by Marchlewski from the contraction of the genus name of the plant (*Gossypium*) and the main structure of the molecule (phenol), to indicate its origin and its chemical nature (Dao, 2002) Figure 5. The content varies from 0.1 to 0.64% depending on the variety of *Gossypium* (Diouf, 2015) and in the seeds is from 0.6 to 1.2 g/kg (ANSES, 2016). As a reminder, the cottonseeds contains gassypurpurin (purple), gossyaerulin (blue), gossyfulivin (orange), gossyverdurin (green) and gossypol (yellow). The Gossypol gland is the most important pigment found in

cottonseed and creates huge problems in seed treatment and the use of cottonseed as a by-product (Agarwal *et al.*, 2003).

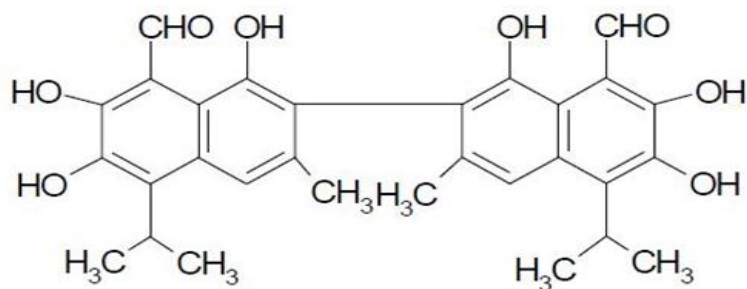

Figure-5. Structure of gossypol.

Source: Cai *et al.* (2004).

The gossypol biogenesis is very different from most polyphenols (Shikimate and acetate pathways). Some authors have always considered gossypol to be a terpene compound since it has been shown to biosynthesize via the terpene pathway (Boune, 2019). The study in 2018 of the biosynthetic pathway of gossypol carried out by Tian and his collaborators identified 146 candidates linked to the biosynthesis of gossypol, four enzymes involved in the biosynthesis process, as well as six intermediates allowing access to gossypol (Benz *et al.*, 1990). The Biosynthesis of gossypol takes place from E, E-farnesyl diphosphate. The CYP706B1 enzyme provides the intermediate 7-hydroxy (+) δ -cadinene, which is a key intermediate in the pathway biosynthesis of gossypol (Boune, 2019). Figure 6 gives a pathway for biosynthesis of gossypol.

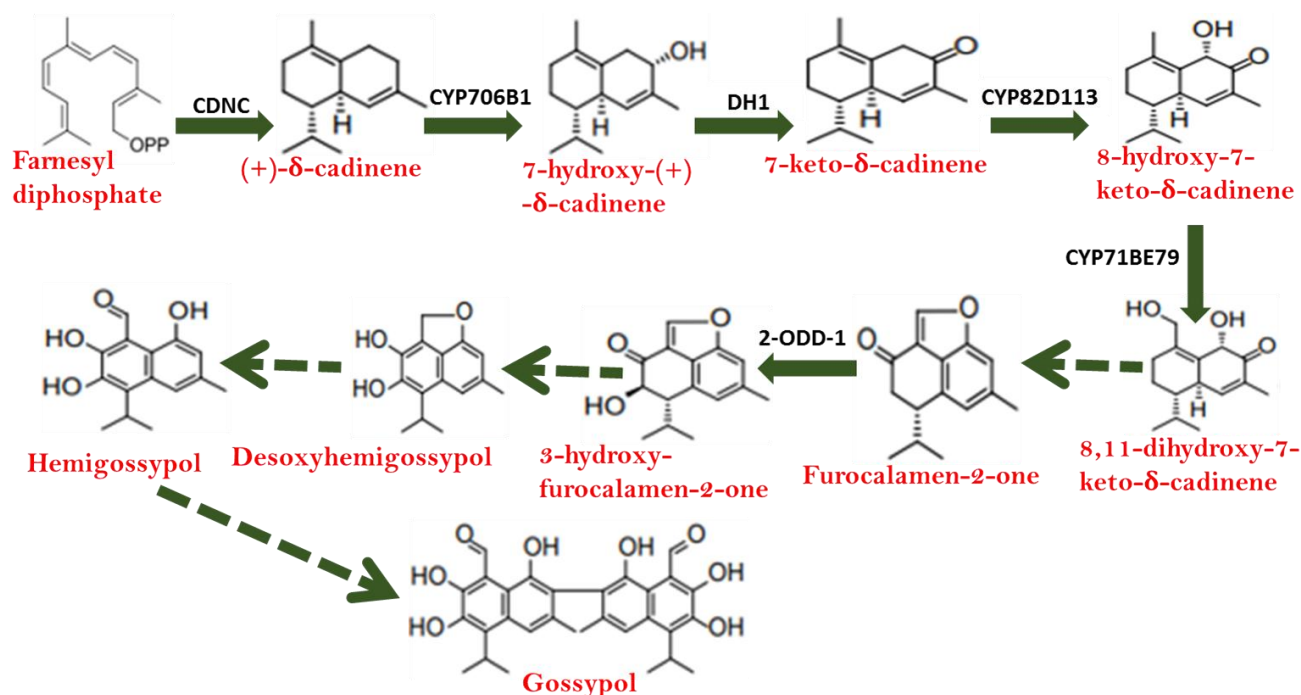

Figure-6. Genes of gossypol pathway enzymes and their expressions.

Source: Tian *et al.* (2018).

6.2. Gossypol Typology

In the cottonseeds, gossypol comes in a free form or linked to "amine" groups (Lyman *et al.*, 1959) or metal ions (Panigrahi *et al.*, 1989) forming, with the free fraction, the total gossypol. Bound gossypol is usually with the proteins of the plant from which gossypol is extracted (Boune, 2019). Chemically, gossypol is a weak acid and easily

oxidizable (Huang *et al.*, 1988). It is a polyphenolic pigment, liposoluble with chemical formula $C_{30}H_{32}O_{12}$, hexahydroxy-5,5"-diisopropyl-1,3,3"-dimethyl- [2,2"-binaphthalene]-8,8"-dicarboxaldehyde (Huang *et al.*, 1988; Henry *et al.*, 2001) comprises four benzene rings with iso-propene branches, hydroxyls, aldehydes or ketones. The naphthalene groups of the molecule make it possible to obtain the (+) and (-)-gossypol enantiomers (Huang *et al.*, 1988; Henry *et al.*, 2001; Gamboa *et al.*, 2001a). The Figure 7 shows the two atropoisomers of gossypol: (aR) - and (aS) gossypol. However, (-) gossypol has the highest optical activity (Joseph *et al.*, 1986; Blackstaffe *et al.*, 1997) while the isomer (+) is eliminated more slowly (EFSA (European Food Safety Authority), 2008). In cotton, (+) gossypol is mainly abundant in cotton varieties (*Gossypium hirsutum*), while the levogyre isomer (-) gossypol is predominant in other varieties such as *Gossypium barbadense* (Zhou and Lin, 1988; Cass *et al.*, 1991). The (-) enantiomer gossypol is the most biologically active form. As a result, it is more toxic than (+) gossypol (Bailey *et al.*, 2000). There are three tautomeric forms: gossypol-aldehyde, gossypol-lactol and gossypol cyclic-carbonyl (Hui, 1996).

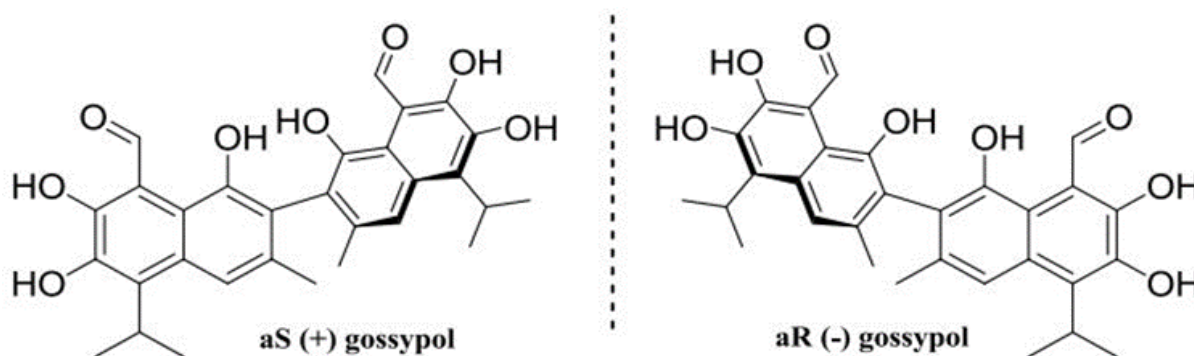

Figure-7. The two atropoisomers of gossypol.

Source: Boune (2019).

6.3. Gossypol in Edible Oils

Gossypol is present in cottonseed oils and is responsible for infertility. This has been demonstrated by Li *et al.* (2007). As early as 1929, through the relationship between contraception and consumption in Jiangxi Province, of cottonseeds oil, extracted by cold pressing (Liu, 1957). This presence would have led to a period of widespread sterility among consumers during this period, hence the interest of research for the development of male contraception (Qian and Wang, 1984; Amini and Kamkar, 2005).

Moreover, the yellow color of this oil is due to gossypol, a pigment that has since been recognized as the agent responsible for the observed birth rate (Dao, 2002). The level of gossypol in the crude oil extracted with a solvent is 0.05 to 0.42% and in the 0.25-0.47% crude screw-pressed oil (Mirghani and Che, 2003). Studies have confirmed the presence of gossypol in cottonseed oil. This is the case of the works of Asmellash and Dagne (1989) specifically in unrefined cottonseed oil at levels between 0.02 and 0.08%; in Baobab seed oil at 10 µg/g (Birnin-Yauri and Garba, 2011). Unrefined cottonseed oil is sometimes used as a pesticide. Thereby, cottonseed oil must be refined to eliminate gossypol, which is a natural toxin (Kanoi, 2004). According to Bailey (1948) the oil with virtually no gossypol is pale yellow in color and rich in vitamin E (Bailey, 1948).

6.4. Toxicity and Health Impact of Gossypol

Monogastrics, such as pork, rabbit, poultry and humans are the species most sensitive to gossypol toxicity, with ruminants being more tolerant (EFSA, 2008). Respiratory disorders, anorexia, chronic nervous breakdown and heart problems frequently lead to death (Gamboa *et al.*, 2001b). Toxicity affects other organs such as the lungs, liver and blood cells; which increases the fragility of red blood cells (EFSA, 2008).

Gossypol reduces the sperm count by half, and can also affect the toxicity of Sertoli and Leydig cells (EFSA, 2008). Gossypol regularly given even in low doses completely suppressed the production of male spermatozoa (Waites, 1986; Waites *et al.*, 1998; Dodou, 2005) whereas in women gossypol ingestion can lead to high fever. Amenorrhea and atrophy of the uterus; which will disrupt estrus cycles, pregnancy and early development of the embryo (EFSA, 2008). At high dose gossypol causes vomiting, loose stools, decreased weight, cytotoxicity of germ cells, increased potassium excretion that can range from 1 to 4% in the urine of men; resulting in hypokalemia (Waites, 1986; EFSA, 2008) neuromuscular disorders sometimes lead to transient paralysis (Waites, 1986) progressive anemia, and morphological changes in the heart and kidneys (EFSA, 2008). The two enantiomers of gossypol have markedly different biological effects. In comparison (+) of gossypol, the enantiomer (-) generally shows more pronounced effects. For example, (-) gossypol is more cytotoxic (Band *et al.*, 1989; Blackstaffe *et al.*, 1997; Shelley *et al.*, 1999) bind more strongly to proteins (Wang *et al.*, 1992; Oliver *et al.*, 2005) is the active anti-spermatogenic agent and is considered more toxic than (+) gossypol (Matlin *et al.*, 1985; Lindberg *et al.*, 1987; Lordelo *et al.*, 2005).

However, gossypol has been used in China for a very long time as a natural remedy for the treatment of bronchitis and as an abortifacient (Vander and Royer, 2000). The antiviral properties of gossypol have been found mainly on the herpes virus (Dao, 2002) example influenza virus, etc. but also an anti-psoriasis activity (Chau, 2008). The inactivating effect of gossypol on HIV-1 in an acellular medium has been studied. Pre-incubations with gossypol at concentrations starting at 100 μ M allow complete destruction of the virus (Polsky *et al.*, 1989).

Gossypol had other activities including antifungal activity, anti-parasitic activity, anti-tumor activity (Dao, 2002). With regard to cancer, gossypol is more active against human carcinoma cells than against bone marrow cancers, the sensitivity of carcinoma cells being matched with the level of LDH in these cells. Cottonseed oil has recently been investigated for use in potential reversible male contraceptives (Waites *et al.*, 1998; Yu and Chan, 1998) hence its pharmacological applications as an oral contraceptive (-) gossypol in men (Chau, 2008). In free form, it is toxic and causes organ damage, heart attacks and can lead to death in humans. Untreated cottonseeds given to bulls can cause sperm malformations and decreased sperm production (D'Mello, 2004). The anticancer properties of gossypol are currently attracting the most interest (Chau, 2008). The Figure 8 shows the effects of gossypol in the body.

6.5. Regulatory Limits and Gossypol Elimination

The detoxification of gossypol is done by physical, chemical or biological treatments such as solvent extraction of oil during trituration, supplementation with amino acids or vitamins and plant improvement work to obtain "glandless" varieties (Diaw *et al.*, 2011). In oil mills, solvent extraction of cottonseeds oils is commonly used (Damaty and Hudson, 1975; Canella and Sodini, 1977; Cherry and Gray, 1981; Rahma and Rao, 1984) and can be grades ranging from 0.03 to 0.14% free gossypol and 1.09 to 1.16% bound gossypol (Proctor *et al.*, 1968; Vix *et al.*, 1971; Yu *et al.*, 1993). Thus, gossypol can be removed from the oil by solvent extraction after extraction of the oil from the seeds, either mechanically or with solvents (Brink and Achigan-Dako, 2012). Double neutralization allows complete elimination of gossypol in cottonseeds oils. As a result, cottonseeds oil can only be refined chemically (Bauer *et al.*, 2010). Gossypol is toxic but can be eliminated during the refining process. Its content in the oil intended for human consumption should be zero. Another type of cotton plant has been introduced. This is cotton without glands (glandless). Cotton without glands contains little or no gossypol in seeds, roots, stems and leaves, but its resistance to diseases, pests and even rats is greatly reduced (Zhang *et al.*, 1999;2001).

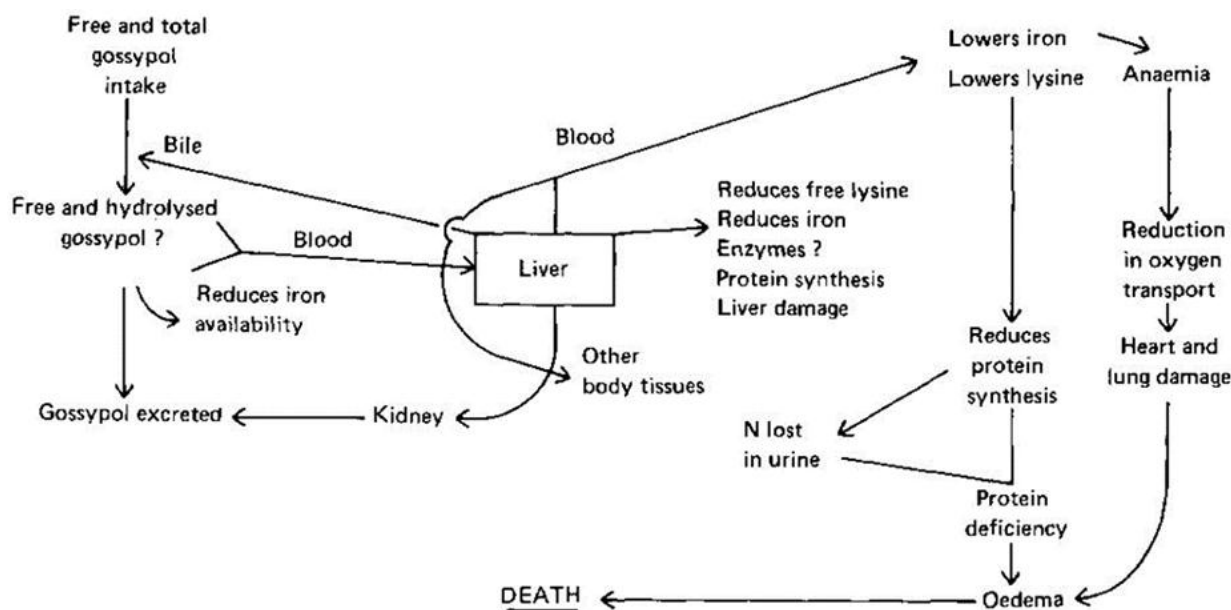

Figure-8. Gossypol in human body.

Source: Archive.unu.edu/unupress/food/8F024e/8F024E11.gif.

6.6. Analytical Methods of Gossypol

Several methods have been developed for the gossypol analysis. These are methods such as HPLC that have been employed (Hanny, 1980). This is the case of Nomeir and Abou-Donia (1982) who reported on the qualitative and quantitative analysis of gossypol by HPLC and its stability in various solvents. Thus, AOCS has adopted methods for determining the value of free and total gossypol using a spectrophotometer or a colorimeter equipped with a filter for maximum transmittance at 440-460 nm. The HPLC method is more precise, efficient and specialized (Nomeir and Abou-Donia, 1982; Wang *et al.*, 1985; Yang and Xiang, 1995). According to Mirghani and Che (2003). Fourier Transform Infrared Spectroscopy (FTIR) has proved to be a potential analytical tool for simple and rapid quantitative analysis of gossypol in cottonseeds oil. Different methods such as polarography, paper, thin film (Asmellash and Dagne, 1989) spectrophotometry, gas chromatography and, recently, HPLC (Asmellash and Dagne, 1989; Yang and Xiang, 1995) were used for gossypol analysis. Some authors such as Birnin-Yauri and Garba (2011) used spectrophotometry to evaluate the gossypol content in oils samples during their study. As for the chemical methods, they are not very specific and the gossypol analogues give positive values resulting in overestimation (Cai *et al.*, 2004).

7. CONCLUSION

Food oils contain contaminants of various origins. These contaminants are either endogenous or exogenous and very varied. These contaminants are dangerous for the consumer. Several arrangements make it possible to reduce, avoid or eliminate these undesirable compounds in foods in particular edible oils by refining process. Refining is essential to eliminate the anti-nutritional factors of oils. Thereby, standards in this area have been developed for the setting of maximum limits to be respected by producers to ensure the foods safety especially oils. Finally, the respect of the good practices of oils manufacture and conservation is essential for oil quality.

Funding: This study received no specific financial support.

Competing Interests: The authors declare that they have no competing interests.

Acknowledgement: All authors contributed equally to write manuscript and reviewed. We thank our Laboratory (LaBIA).

REFERENCES

- Abalaka, J., 1984. Aflatoxin distribution in edible oil-extracting plants and in poultry feedmills. *Food and Chemical Toxicology*, 22(6): 461-463. Available at: [https://doi.org/10.1016/0278-6915\(84\)90330-2](https://doi.org/10.1016/0278-6915(84)90330-2).
- Abalaka, J.A. and J.A. Elegbede, 1982. Aflatoxin distribution and total microbial counts in an edible oil extracting plant. I. Preliminary observations. *Food and Chemical Toxicology*, 20(1): 43-46. Available at: [https://doi.org/10.1016/S0278-6915\(82\)80007-0](https://doi.org/10.1016/S0278-6915(82)80007-0).
- Abalo, A., 2017. Traditional processing and marketing of palm oil. European University Editions. Available from <https://www.memoireonline.com/01/09/1856/Transformation-traditionnelle-et-commercialisation-de-lhuile-de-palmiste-cas-de-la-region-maritime.html>.
- Abrunhosa, L., H. Morales, C. Soares, T. Calado, A.S. Vila-Chã, M. Pereira and A. Venâncio, 2016. A review of mycotoxins in food and feed products in Portugal and estimation of probable daily intakes. *Critical Reviews in Food Science and Nutrition*, 56(2): 249-265. Available at: <https://doi.org/10.1080/10408398.2012.720619>.
- Adams, R., T. Geissman and J. Edwards, 1960. Gossypol, a pigment of cottonseed. *Chemical Reviews*, 60(6): 555-574. Available at: <https://doi.org/10.1021/cr60208a002>.
- Addis, P. and G. Warner, 1991. The potential health aspects of lipid oxidation products in food. *Free Radicals and Food Additives*: 77-119. Available from https://books.google.fr/books/about/The_potential_health_aspects_of_lipid_ox.html?id=OOrPMgEACAAJ&redir_esc=y.
- Addis, P.B., 1986. Occurrence of lipid oxidation products in foods. *Food and Chemical Toxicology*, 24(10-11): 1021-1030. Available at: [https://doi.org/10.1016/0278-6915\(86\)90283-8](https://doi.org/10.1016/0278-6915(86)90283-8).
- AFSSA (French Food Safety Agency), 2009. Risk assessment linked to the presence of mycotoxins in the human and animal food chains. Final Report.
- Afzali, D., M. Ghanbarian, A. Mostafavi, T. Shamspur and S. Ghaseminezhad, 2012. A novel method for high preconcentration of ultra trace amounts of B1, B2, G1 and G2 aflatoxins in edible oils by dispersive liquid-liquid microextraction after immunoaffinity column clean-up. *Journal of Chromatography A*, 1247: 35-41. Available at: <https://doi.org/10.1016/j.chroma.2012.05.051>.
- Agarwal, D.K., P. Singh, M. Chakrabarty, A.J. Shaikh and S.G. Gayal, 2003. Cottonseed oil quality, utilization and processing. Available from http://www.cicr.org.in/pdf/cottonseed_oil.pdf.
- Ali, R.F., 2010. Improvement the stability of fried sunflower oil by using different levels of pomposia (*Syzygium cumini*). *Electronic Journal of Environmental, Agricultural and Food Chemistry*, 9(2): 396-403.
- Alshannaq, A. and J.H. Yu, 2017. Occurrence, toxicity, and analysis of major mycotoxins in food. *International Journal of Environmental Research and Public Health*, 14(6): 1-20. Available at: <https://doi.org/10.3390/ijerph14060632>.
- Amini, A. and F. Kamkar, 2005. The effects of gossypol on spermatogenesis in NMRI mice. *Iranian Journal of Science and Technology (Sciences)*, 29(1): 123-133.
- Anjorin, S., H. Makun and H. Ihenecho, 2008. Effect of *Lippia Multiflora* leaf extract and *aspergillus flavus* on germination and vigour indices of sorghum Bicolor [L](Moench). *International Journal of Tropical Agriculture and Food System*, 2(1): 130-134.
- Anon, 1989. IARC monographs on the evaluation of carcinogenic risks to humans: Diesel and engine exhausts and some Nitroarenes. *IARC Monogr Eval Carcinog Risks Hum*, 33(3): 174. Available at: <https://doi.org/10.1007/BF02897877>.
- ANSES, 2016. Opinion of the national agency for food safety, environment, and labor relating to the analysis of monitoring and control plans for undesirable substances in animal feed. Available from <https://www.anses.fr/fr/system/files/ALAN2015SA0076.pdf>.
- Asmellash, S. and E. Dagne, 1989. Gossypol levels in cottonseed oil and cottonseed cake produced in Ethiopia. *Bulletin of the Chemical Society of Ethiopia*, 3(1): 51-55.

- Bahrani, R., Y. Shahbazi and Z. Nikousefat, 2016. Occurrence and seasonal variation of aflatoxin in dairy cow feed with estimation of aflatoxin M₁ in milk from Iran. *Food and Agricultural Immunology*, 27(3): 388-400. Available at: <https://doi.org/10.1080/09540105.2015.1109613>.
- Bailey, A.E., 1948. Cottonseed and cottonseed products. Their chemistry and chemical technology. Cottonseed and cottonseed products. Their chemistry and chemical technology. New York: Interscience Publishers.
- Bailey, C.A., R.D. Stipanovic, M.S. Ziehr, A.U. Haq, M. Sattar, L.F. Kubena, H.L. Kim and R. de M. Vieira, 2000. Cottonseed with a high (+)-to (-)-gossypol enantiomer ratio favorable to broiler production. *Journal of Agricultural and Food chemistry*, 48(11): 5692-5695. Available at: <https://doi.org/10.1021/jf000211n>.
- Baldi, I., P. Lebailly, B. Mohammed-Brahim, L. Letenneur, J.F. Dartigues and P. Brochard, 2003. Neurodegenerative diseases and exposure to pesticides in the elderly. *American Journal of Epidemiology*, 157(5): 409-414. Available at: <https://doi.org/10.1093/aje/kwf216>.
- Band, V., A.P. Hoffer, H. Band, A.E. Rhinehardt, R.C. Knapp, S.A. Matlin and D.J. Anderson, 1989. Antiproliferative effect of gossypol and its optical isomers on human reproductive cancer cell lines. *Gynecologic Oncology*, 32(3): 273-277. Available at: [https://doi.org/10.1016/0090-8258\(89\)90623-9](https://doi.org/10.1016/0090-8258(89)90623-9).
- Bao, L., M.W. Trucksess and K.D. White, 2010. Determination of aflatoxins B₁, B₂, G₁, and G₂ in olive oil, peanut oil, and sesame oil. *Journal of AOAC International*, 93(3): 936-942.
- Bauer, W.J., R. Badoud and J. Löliger, 2010. Food science and technology: Principles of constituent chemistry and process technology. PPUR Polytechnic Presses. Available from <https://www.amazon.fr/Science-technologie-aliments-Principes-constituants/dp/2880747546>.
- Benabid, H., 2009. Characterization of Algerian olive oil contributions of chemometric methods. Algeria: INATAA. Mentouri University of Constantine.
- Benjelloun, N., 2014. Argan oil: Pharmacological properties and implementation of a control process. Doctoral Thesis.
- Bennett, J.W. and M. Klich, 2003. Mycotoxins. *Clinical Microbiology Review*, 16: 497-516. Available at: <http://dx.doi.org/10.1128/CMR.16.3.497-516.2003>.
- Benz, C.C., M.A. Keniry, J.M. Ford, A.J. Townsend, F.W. Cox, S. Palayoor, S.A. Matlin, W.N. Hait and K.H. Cowan, 1990. Biochemical correlates of the antitumor and antimitochondrial properties of gossypol enantiomers. *Molecular Pharmacology*, 37(6): 840-847.
- Benzine, M., 2006. Pesticides: Toxicity, residues and analysis. Laboratory Technologies, 1. Available from <https://revues.imist.ma/index.php?journal=technolab&page=article&op=download&path%5B%5D=315&path%5B%5D=294>.
- Berthiller, F., C. Hametner, P. Krenn, W. Schweiger, R. Ludwig, G. Adam, R. Krska and R. Schuhmacher, 2009. Preparation and characterization of the conjugated Fusarium mycotoxins zearalenone-4 O-β-D-glucopyranoside, α-zearalenol-4 O-β-D-glucopyranoside and β-zearalenol-4 O-β-D-glucopyranoside by MS/MS and two-dimensional NMR. *Food Additives and Contaminants*, 26(2): 207-213. Available at: <https://doi.org/10.1080/02652030802399034>.
- Betina, V., 1994. Bioactive secondary metabolite of microorganisms. *Bibliographical Bases Pascal and Francis*, 30: 468.
- Birin-Yauri, U.A. and S. Garba, 2011. Comparative studies on some physicochemical properties of baobab, vegetable, peanut and palm oils. *Nigerian Journal of Basic and Applied Sciences*, 19(1): 64- 67. Available at: <http://dx.doi.org/10.4314/njbas.v19i1.69345>.
- Blackstaffe, L., M. Shelley and R. Fish, 1997. Cytotoxicity of gossypol enantiomers and its quinone metabolite gossypolone in melanoma cell lines. *Melanoma Research*, 7(5): 364-372. Available at: <https://doi.org/10.1097/00008390-199710000-00002>.
- Boland, J., I. Koomen, J. van Lidth De Jeude and J. Oudejans, 2004. Pesticides: Composition, use and risks. Wageningen: Agromisa Foundation.

- Bordin, K., M.M. Sawada, C.E. Da Costa Rodrigues, C.R. Da Fonseca and C.A.F. Oliveira, 2014. Incidence of aflatoxins in oil seeds and possible transfer to oil: A review. *Food Engineering Reviews*, 6(1-2): 20-28. Available at: <https://doi.org/10.1007/s12393-014-9076-9>.
- Boune, M.V.S., 2019. Valorization in organic synthesis of phytoconstituents (gossypol derivatives) extracted from *cienfuegosia digitata*. Cav. Doctoral Thesis, University of Normandy and the University of Nouakchott.
- Bouvier, G., 2005. Contribution to the evaluation of the exposure of the population of Ile-de-France to pesticides. Doctoral Thesis, René Descartes-Paris V University, France.
- Bové, F.J., 1970. The history of ergot. In the story of Ergot. Karger Publishers. pp: 134-165. Available from <https://doi.org/10.1159/000388183>.
- Brink, M. and E.G. Achigan-Dako, 2012. Fiber plants. PROTA. Available from https://books.google.fr/books?hl=fr&lr=&id=lspmAgAAQBAJ&oi=fnd&pg=PA6&dq=Brink,+M.+and+E.G.+Achigan+Dako,+2012.+Fiber+plants.+PROTA.&ots=eXY5r3HYp0&sig=ZxSIDJ8v6Bt5iyyS5MrSV_UvVRs#v=onepage&q=Brink%2C%20M.%20and%20E.G.%20Achigan-Dako%2C%202012.%20Fiber%20plants.%20PROTA.&f=false.
- Brochard, G. and L.C. Bâcle, 2009. Mycotoxin in the workplace. *Documents for the Occupational Physician*, 119: 299-323.
- Cai, Y., H. Zhang, Y. Zeng, J. Mo, J. Bao, C. Miao, J. Bai, F. Yan and F. Chen, 2004. An optimized gossypol high-performance liquid chromatography assay and its application in evaluation of different gland genotypes of cotton. *Journal of Biosciences*, 29(1): 67-71. Available at: <https://doi.org/10.1007/bf02702563>.
- Cairns-Fuller, V., D. Aldred and N. Magan, 2005. Water, temperature and gas composition interactions affect growth and ochratoxin A production by isolates of *penicillium verrucosum* on wheat grain. *Journal of Applied Microbiology*, 99(5): 1215-1221. Available at: <https://doi.org/10.1111/j.1365-2672.2005.02695.x>.
- Camard, J.P. and C. Magdelaine, 2001. Phytosanitary products: risks for the environment and health, knowledge of uses in non-agricultural areas. IAU IdF / ORS: 58. Available from https://www.iau-idf.fr/fileadmin/NewEtudes/Etude_675/Produits_phytosanitaires._Risques_pour_l_environnement_et_la_sante_avec_signets.pdf.
- Camin, F., R. Larcher, M. Perini, L. Bontempo, D. Bertoldi, G. Gagliano, G. Nicolini and G. Versini, 2010. Characterization of authentic Italian extra-virgin olive oils by stable isotope ratios of C, O and H and mineral composition. *Food Chemistry*, 118(4): 901-909. Available at: <https://doi.org/10.1016/j.foodchem.2008.04.059>.
- Canella, M. and G. Sodini, 1977. Extraction of gossypol and oligosaccharides from oilseed meals. *Journal of Food Science*, 42(5): 1218-1219. Available at: <https://doi.org/10.1111/j.1365-2621.1977.tb14463.x>.
- Casas, J.S., C.D.M. Gordillo, E.O. Bueno, J.M. Expósito, M.F. Mendoza, T.A. Hierro, L.G. Gonzalez and M.M. Cano, 2009. Characteristics of virgin olive oils from the olive zone of extremadura (spain), and an approximation to their varietal origin. *Journal of the American Oil Chemists' Society*, 86(10): 933-940. Available at: <https://doi.org/10.1007/s11746-009-1428-x>.
- Cass, Q.B., E. Tiritan, S.A. Matlin and E.C. Freire, 1991. Gossypol enantiomer ratios in cotton seeds. *Phytochemistry*, 30(8): 2655-2657. Available at: [https://doi.org/10.1016/0031-9422\(91\)85117-i](https://doi.org/10.1016/0031-9422(91)85117-i).
- Catherine, R.R., 2014. Plant protection products: Innovation and security for sustainable agriculture. Lavoisier. Available from <https://www.lavoisier.fr/livre/agriculture/produits-de-protection-des-plantes/regnault-roger/descriptif-9782743015398>.
- Cavaliere, C., P. Foglia, C. Guarino, M. Nazzari, R. Samperi and A. Lagana, 2007. Determination of aflatoxins in olive oil by liquid chromatography–tandem mass spectrometry. *Analytica Chimica Acta*, 596(1): 141-148. Available at: <https://doi.org/10.1016/j.aca.2007.05.055>.
- CEC, 2006. Commission Regulation (EC) No 1881/2006 of 19 December 2006 fixing maximum levels for certain contaminants in food. Text with EEA relevance. Available from <https://eur-lex.europa.eu/LexUriServ/LexUriServ.do?uri=OJ:L:2006:364:0005:0024:FR:PDF>.

- Chandler, D., A.S. Bailey, G.M. Tatchell, G. Davidson, J. Greaves and W.P. Grant, 2011. The development, regulation and use of biopesticides for integrated pest management. *Philosophical Transactions of the Royal Society B: Biological Sciences*, 366(1573): 1987-1998.
- Chau, N.T.T., 2008. Total racemic synthesis of structural analogues of gossypol and apogossypol involving aromatic metalation reactions. Doctoral Thesis, University of Maine, France.
- Chen, S., X. Yu, X. He, D. Xie, Y. Fan and J. Peng, 2009. Simplified pesticide multiresidues analysis in fish by low-temperature cleanup and solid-phase extraction coupled with gas chromatography/mass spectrometry. *Food Chemistry*, 113(4): 1297-1300. Available at: <https://doi.org/10.1016/j.foodchem.2008.08.045>.
- Cherry, J.P. and M.S. Gray, 1981. Methylene chloride extraction of gossypol from cottonseed products. *Journal of Food Science*, 46(6): 1726-1733. Available at: <https://doi.org/10.1111/j.1365-2621.1981.tb04473.x>.
- Chulze, S.N., 2010. Strategies to reduce mycotoxin levels in corn during storage: A review. *Food Additives and Contaminants*, 27(5): 651-657. Available at: <https://doi.org/10.1080/19440040903573032>.
- Codex, A., 1999. Standard for vegetable oils with a specific name. Codex-stan 210-1999. Adopted 1999. Revisions 2001, 2003, 2009. Amended 2005, 2011, 2013. 1-17. Available from <https://www.eacce.org.ma/wp-content/uploads/2016/05/Codex-NORME-POUR-LES-HUILES-V%C3%89G%C3%89TALES-PORTANT-UN-NOM-SP%C3%89CIFIQUE.pdf>.
- Codex, A., 2003. Maximum residue limits for processed or ready-to-eat products intended for human and animal consumption. Thirty-Fifth Session Rotterdam (Netherlands), March 13-April 5, 2003. pp: 30.
- Compaoré, H., H. Sawadogo-Lingani, S. Samandoulougou, F. Guira, A. Savadogo and A.S. Traore, 2017. Ability of three mold strains to produce extracellular enzymes in solid medium in Burkina Faso. *Journal of Applied Biosciences*, 110(1): 10776-10782. Available at: <http://dx.doi.org/10.4314/jab.v110i1.7>.
- Corbett, J.R., K. Wright and A.C. Baillie, 1984. Compounds interfering with cell division. The biochemical mode of action of pesticides. 2nd Edn., London: Academic Press, 202.
- Coumoul, X., 2016. Food contaminants and the risk of cancer. *Nutrition and Dietetics Notebooks*, 51(2): 104-110. Available at: <https://doi.org/10.1016/j.cnd.2016.01.006>.
- Couteux, A. and C. Salaün, 2009. Acta phytosanitary index. 45th Edn.: MAME. Retrieved from: <http://www.fao.org/tempref/docrep/fao/007/y5159e/y5159e04.pdf>.
- Creppy, E.E., F.C. Stormer, R. Rösenthaller and G. Dirheimer, 1983. Effects of two metabolites of ochratoxin A, (4R)-4-hydroxyochratoxin A and ochratoxin alpha, on immune response in mice. *Infection and Immunity*, 39(3): 1015-1018. Available at: <https://doi.org/10.1128/iai.39.3.1015-1018.1983>.
- CSP, 2018. Global list of pesticides authorized by the Sahelian Pesticides Committee: 47. Available from www.insah.org/doc/liste_globale_pesticides_autorises_par_CSP_version_mai-2018.pdf.
- Cubero-Leon, E., R. Penalver and A. Maquet, 2014. Review on metabolomics for food authentication. *Food Research International*, 60: 95-107. Available at: <https://doi.org/10.1016/j.foodres.2013.11.041>.
- Cuvelier, M.E. and M.N. Maillard, 2012. Stability of edible oils during storage. *Oilseeds, Fats, Lipids*, 19(2): 125-132. Available at: <https://doi.org/10.1051/ocl.2012.0440>.
- D'Mello, J., 2004. Contaminants and toxins in animal feeds. *FAO Animal Production and Health Paper*: 107-128. Available from <http://www.fao.org/tempref/docrep/fao/007/y5159e/y5159e04.pdf>.
- D'Mello, J.P.F., J.K. Porter and C.M. Placinta, 1997. Fusarium mycotoxins. In: D'MELLO, J.P.F. (Ed.), *Handbook of Plant and Fungal Toxicants*. Boca Raton, FL: CRC Press. pp: 287-301.
- Dahlke, K., 1998. An enzymatic process for the physical refining of seed oils. *Chemical Engineering & Technology: Industrial Chemistry-Plant Equipment-Process Engineering-Biotechnology*, 21(3): 278-281. Available at: [https://doi.org/10.1002/\(sici\)1521-4125\(199803\)21:3<278::aid-ceat278>3.0.co;2-9](https://doi.org/10.1002/(sici)1521-4125(199803)21:3<278::aid-ceat278>3.0.co;2-9).
- Damaty, S.M. and B.J. Hudson, 1975. Preparation of low-gossypol cottonseed flour. *Journal of the Science of Food and Agriculture*, 26(1): 109-115. Available at: <https://doi.org/10.1002/jsfa.2740260114>.

- Daniels, J.L., A.F. Olshan and D.A. Savitz, 1997. Pesticides and childhood cancers. *Environmental Health Perspectives*, 105(10): 1068-1077.
- Dao, V.T., 2002. Gossypol and its new derivatives: Synthesis and study of biological activities. Doctoral Thesis, University of Paris Sud-Paris XI, France.
- De Kock, J., W. De Greyt, V. Gibon and M. Kellens, 2005. Recent developments in refining and modifications: Elimination of contaminants in edible oils and reduction in the level of trans fatty acids. *Oilseeds, Fats, Fat*, 12(5-6): 378-384. Available at: <http://dx.doi.org/10.1051/ocl.2005.0378>.
- Deravel, J., F. Krier and P. Jacques, 2013. Biopesticides, supplements and alternatives to chemical plant protection products (bibliographic summary). *Biotechnology, Agronomy, Society and Environment*, 18(2): 220-232.
- Dewailly, É., P. Ayotte, S. Bruneau, S. Gingras, M. Belles-Isles and R. Roy, 2000. Susceptibility to infections and immune status in inuit infants exposed to organochlorines. *Environmental Health Perspectives*, 108(3): 205-211. Available at: <https://doi.org/10.1289/ehp.00108205>.
- DGAL, 2000. Data on the exposure of the French population to pesticide, lead, cadmium, arsenic and radionuclide residues from food. *Our food*; 24. Available from <https://www.caducee.net/Fiches-techniques/Notrealimentation/contaminants.asp>.
- Di Renzo, L., P. Gualtieri, L. Romano, G. Marrone, A. Noce, A. Pujia, M.A. Perrone, V. Aiello, C. Colica and A. De Lorenzo, 2019. Role of personalized nutrition in chronic-degenerative diseases. *Nutrients*, 11(8): 1-24. Available at: <https://doi.org/10.3390/nu11081707>.
- Diaw, M.T., A. Dieng, G. Mergeai and J.L. Hornick, 2011. Cottonseed co-products in feed for broilers. In *Annals of Veterinary Medicine*, 155: 61-82.
- Dieme, E., R. Fall, I. Sarr, F. Sarr, D. Traore and M. Seydi, 2016. Aflatoxin contamination of cereals in Africa: Review of existing control methods. *International Journal of Biological and Chemical Sciences*, 10(5): 2285-2299. Available at: <http://dx.doi.org/10.4314/ijbcs.v10i5.27>.
- Dijkstra, A.J., 1998. Degumming revisited. *Oleaginous Corps Gras Lipids*, 5(5): 367-370. Available at: <https://doi:10.1007/978-1-4614-3351-4>.
- Dikshith, T., S. Kumar, G. Tandon, R. Raizada, P. Ray, J. Woodrow, J. Wong, J. Seiber, A. Bimurzaev and G. Nikonov, 1989. Pesticide residues in edible oils and oil seeds. *Bulletin of Environmental Contamination and Toxicology*, 42(1): 50-56. Available at: <https://doi.org/10.1007/bf01699203>.
- Diop, A., 2013. Diagnosis of pesticide use practices and quantification in the Niayes area of Dakar (Senegal). *Littoral*. Available from file:///C:/Users/nghf/Downloads/DIOPAmadou%20(4).pdf.
- Diouf, F.B.H., 2015. Analysis of the genetic determinism of the inhibition of gossypol synthesis in the seed in the progeny of the hybrid [(*Gossypium hirsutum* L. x *G. raimondii* Ulb.)² x *G. sturtianum* Willis]. Doctoral Thesis, University of Liège, Belgium.
- Dodou, K., 2005. Investigations on gossypol: Past and present developments. *Expert Opinion on Investigational Drugs*, 14(1): 1419-1434. Available at: <https://doi.org/10.1517/13543784.14.11.1419>.
- EFSA (European Food Safety Authority), 2008. Scientific opinion of the panel on contaminants in the food chain on a request from the European Commission on gossypol as undesirable substance in animal feed. *The EFSA Journal*, 908: 1-55.
- Elzupir, A.O., M.A. Suliman, I.A. Ibrahim, M.H. Fadul and A.M. Elhussien, 2010. Aflatoxins levels in vegetable oils in Khartoum State, Sudan. *Mycotoxin Research*, 26(2): 69-73. Available at: <https://doi.org/10.1007/s12550-010-0041-z>.
- Engel, E., M. Meurillon, C. Planche and P. Peyret, 2014. Fate of toxic food contaminants in the digestive environment. *Agronomic Innovations*, 36: 135-149.
- Escobar, J., S. Lorán, I. Giménez, E. Ferruz, M. Herrera, A. Herrera and A. Ariño, 2013. Occurrence and exposure assessment of fusarium mycotoxins in maize germ, refined corn oil and margarine. *Food and Chemical Toxicology*, 62: 514-520. Available at: <https://doi.org/10.1016/j.fct.2013.09.020>.

- Evrard, J., X.P.X. Pages, C. Argenson and O. Morin, 2007. Processes for obtaining and nutritional compositions of sunflower, olive and rapeseed oils. *Nutrition and Diet Books*, 1(42): 13-23. Available at: [https://doi.org/10.1016/S0007-9960\(07\)91235-3](https://doi.org/10.1016/S0007-9960(07)91235-3).
- Fanelli, C. and A.A. Fabbri, 1989. Relationship between lipids and aflatoxin biosynthesis. *Mycopathologia*, 107(2-3): 115-120. Available at: <https://doi.org/10.1007/BF00707547>.
- Fangeat, L., 2008. Mycotoxins in cattle. Doctoral Dissertation, Thesis Presented at Claude University.
- FAO, 1986. International code of conduct on the distribution and use of pesticides. Rome: Food and Agriculture Organization of the United Nations. pp: 28
- FAO, 1993. Food codex commission: Codex standards for fats, oils and derived products. Rome: CAC, 8.
- Farhoosh, R. and K.R. Esmaeilzadeh, 2009. Anti-rancidity effects of sesame and rice bran oils on canola oil during deep frying. *Journal of the American Oil Chemists' Society*, 86(6): 539-544. Available at: <https://doi.org/10.1007/s11746-009-1382-7>.
- Fellinger, A., 2006. Worldwide mycotoxin regulations and analytical challenges. World Grain Summit: Foods and Beverages: 17-20.
- Fenik, J., M. Tankiewicz and M. Biziuk, 2011. Properties and determination of pesticides in fruits and vegetables. *Trends in Analytical Chemistry*, 30(6): 814-826. Available at: <https://doi.org/10.1016/j.trac.2011.02.008>.
- Ferrer, C., M.J. Gómez, J.F. García-Reyes, I. Ferrer, E.M. Thurman and A.R. Fernández-Alba, 2005. Determination of pesticide residues in olives and olive oil by matrix solid-phase dispersion followed by gas chromatography/mass spectrometry and liquid chromatography/tandem mass spectrometry. *Journal of Chromatography A*, 1069(2): 83-194. Available at: <https://doi.org/10.1016/j.chroma.2005.02.015>.
- Fillatre, Y., 2011. Phytosanitary products: Development of a multi-residue analysis method in essential oils by coupling liquid chromatography with mass spectrometry in tandem mode. Doctoral Thesis, University of Angers.
- Fine, F., C. Brochet, M. Gaud, P. Carre, N. Simon, F. Ramli and F. Joffre, 2016. Micronutrients in vegetable oils: The impact of crushing and refining processes on vitamins and antioxidants in sunflower, rapeseed, and soybean oils. *European Journal of Lipid Science and Technology*, 118(5): 680-697. Available at: <https://doi.org/10.1002/ejlt.201400400>.
- Fink-Gremmels, J., 2008. Mycotoxins in cattle feeds and carry-over to dairy milk: A review. *Food Additives and Contaminants*, 25(2): 172-180. Available at: <https://doi.org/10.1080/02652030701823142>.
- Firmin, S., 2011. Detoxification efficiency of aflatoxin B1 and ochratoxin A by an organic adsorbent: evaluation by excretion balance and toxicokinetic parameters in rats and dairy sheep. Doctoral Thesis, Blaise Pascal University - Clermont-Ferrand II, NNT.
- Frankel, E.N., 1989. The antioxidant and nutritional effects of tocopherols, ascorbic acid and beta-carotene in relation to processing of edible oils. *Library Nourishment and Diet*(43): 297-312. Available at: <https://doi.org/10.1159/000416714>.
- Fuentes, E., M.E. Báez and A. Quiñones, 2008. Suitability of microwave-assisted extraction coupled with solid-phase extraction for organophosphorus pesticide determination in olive oil. *Journal of Chromatography A*, 1207(1-2): 38-45. Available at: <https://doi.org/10.1016/j.chroma.2008.08.051>.
- Gamboa, D.A., M.C. Calhoun, S.W. Kuhlmann, A.U. Haq and C.A. Bailey, 2001a. Use of expander cottonseed meal in broiler diets formulated on a digestible amino acid basis. *Poultry science*, 80(6): 789-794. Available at: <https://doi.org/10.1093/ps/80.6.789>.
- Gamboa, D.A., M.C. Calhoun, S.W. Kuhlmann, A.U. Haq and C.A. Bailey, 2001b. Tissue distribution of gossypol enantiomers in broilers fed various cottonseed meals. *Poultry Science*, 80(7): 920-925.
- García-Reyes, J.F., C. Ferrer, M.J. Gómez-Ramos, A.R. Fernández-Alba and A. Molina-Díaz, 2007. Determination of pesticide residues in olive oil and olives. *Trac Trends in Analytical Chemistry*, 26(3): 239-251.
- Gauthier, A., 2016. Mycotoxins in food and their impact on health PhD. Thesis, University of Bordeaux, Bordeaux: France. Available from <https://dumas.ccsd.cnrs.fr/dumas-01315198/document>.

- Genot, C. and M.C. Michalski, 2010. Metabolic impact of lipid structures and oxidation in food. *Agronomic Innovations*, 10: 43-67.
- Gerrit, V.D., 2008. Industrial experiences with pesticide removal during edible oil refining. *European Journal of Lipid Science and Technology*, 110(11): 982-989. Available at: <https://doi.org/10.1002/ejlt.200890038>.
- Gibon, V. and A. Tirtiaux, 1998. Un raffinage SOFT®: Innovations technologiques. *OCL. Oléagineux, Corps Gras, Lipides*, 5(5): 371-377.
- Greenlee, A.R., T.E. Arbuckle and P.H. Chyou, 2003. Risk factors for female infertility in an agricultural region. *Epidemiology*, 14(4): 429-436. Available at: <https://doi.org/10.1097/01.EDE.0000071407.15670.aa>.
- Gromadzka, J. and W. Wardencki, 2011. Trends in edible vegetable oils analysis. Part A. Determination of different components of edible oils-a review. *Polish Journal of Food and Nutrition Sciences*, 61(1): 33-43. Available at: <https://doi.org/10.2478/v10222-011-0002-z>.
- Guardia, R.M., A. Ruiz Medina, D.A. Molina and C.M.J. Ayora, 2006. Influence of harvesting method and washing on the presence of pesticide residues in olives and olive oil. *Journal of Agricultural and Food chemistry*, 54(22): 8538-8544. Available at: <https://doi.org/10.1021/jf0615911>.
- Guéguen, M., J.C. Amiard, N. Arnich, P.M. Badot, D. Claisse, T. Guérin and J.P. Vernoux, 2011. Shellfish and residual chemical contaminants: Hazards, monitoring, and health risk assessment along French coasts. Available from http://dx.doi.org/10.1007/978-1-4419-9860-6_3.
- Guerre, P., 1998. Main mycotoxicoses observed in ruminants. *The Veterinary Point*, 29: 1231-1238.
- Guezlane-Tebibel, N., N. Bouras and M. Ould El Hadj, 2016. Mycotoxins: A public health danger. *Algerian Journal of Arid Environment*, 6(1).
- Hadjeba-Medjdoub, K., 2012. Risk of multi-contamination with mycotoxins and means of deactivation by the walls of yeasts and yeasts enriched in glutathione or seleno-methionine. Doctoral Thesis.
- Halliwell, B. and J.C. Gutteridge, 1984. Lipid peroxidation, oxygen radicals, cell damage, and antioxidant therapy. *The Lancet*, 323(8391): 1396-1397. Available at: [https://doi.org/10.1016/s0140-6736\(84\)91886-5](https://doi.org/10.1016/s0140-6736(84)91886-5).
- Hanny, B.W., 1980. Gossypol, flavonoid, and condensed tannin content of cream and yellow anthers of five cotton (*Gossypium hirsutum* L.) cultivars. *Journal of Agricultural and Food Chemistry*, 28(3): 504-506. Available at: <https://doi.org/10.1021/jf60229a021>.
- Harris, B. and C.R. Staples, 1992. The problems of mycotoxins in dairy cattle rations. Cooperative Extension Service, University of Florida, Institute of Food and Agricultural Sciences. Available from <https://ufdcimages.uflib.ufl.edu/IR/00/00/17/05/00001/DS15200.pdf>.
- Hassall, K.A., 1982. The chemistry of pesticides: Their metabolism, mode of action and uses in crop protection. Macmillan. Available from <https://www.cabdirect.org/cabdirect/abstract/19840771286>.
- He, Z., Y. Wang, L. Wang, Y. Peng, W. Wang and X. Liu, 2017. Determination of 255 pesticides in edible vegetable oils using QuEChERS method and gas chromatography tandem mass spectrometry. *Analytical and Bioanalytical Chemistry*, 409(4): 1017-1030. Available at: <https://doi.org/10.1007/s00216-016-0016-9>.
- Henry, M., G. Pesti and T. Brown, 2001. Pathology and histopathology of gossypol toxicity in broiler chicks. *Avian Diseases*, 45(3): 598-604. Available at: <https://doi.org/10.2307/1592900>.
- Hernández-Borges, J., J.C. Cabrera, M.A. Rodríguez-Delgado, E.M. Hernández-Suárez and V.G. Saúco, 2009. Analysis of pesticide residues in bananas harvested in the Canary Islands (Spain). *Food Chemistry*, 113(1): 313-319. Available at: <https://doi.org/10.1016/j.foodchem.2008.07.042>.
- Heussner, A.H. and L.E. Bingle, 2015. Comparative ochratoxin toxicity: A review of the available data. *Toxins*, 7(10): 4253-4282. Available at: <https://doi.org/10.3390/toxins7104253>.
- Hodgson, E. and P.E. Levi, 1996. Pesticides: An important but underused model for the environmental health sciences. *Environmental Health Perspectives*, 104(suppl 1): 97-106. Available at: <https://doi.org/10.2307/3432700>.

- Holbrook, C.C., B.Z. Guo, D.M. Wilson and C. Kvien, 2004. Effect of drought tolerance on preharvest aflatoxin contamination in peanut. Proceedings of the 4th International Crop Science Congress Brisbane, Australia.
- Huang, L., Y.-K. Si, G. Snatzke, D.-K. Zheng and J. Zhou, 1988. Absolute configuration of gossypol. Collection of Czechoslovak Chemical Communications, 53(11): 2664-2666. Available at: <https://doi.org/10.1135/cccc19882664>.
- Hui, Y.H., 1996. Bailey's industrial oil and fat products. Edible Oil and Fat Products Oils and Oil Seeds (No. L-0332). John Wiley and Sons, 2.
- Huybrechts, B., E.K. Tangni, P. Debongnie, J. Geys and A. Callebaut, 2013. Analytical methods for the determination of mycotoxins in agricultural products: A review. Cahiers Agricultures, 22(3): 202-215. Available at: <https://doi.org/10.1684/agr.2013.0616>.
- Idris, Y.M., A.A. Mariod, I.A. Elnour and A.A. Mohamed, 2010. Determination of aflatoxin levels in Sudanese edible oils. Food and Chemical Toxicology, 48(8-9): 2539-2541. Available at: <https://doi.org/10.1016/j.fct.2010.05.021>.
- International Agency for Research on Cancer, 1993. Monographs on the evaluation of carcinogenic risks to humans: Heterocyclic amines and mycotoxins. Lyon, France: IARC, 56.
- Iterg, 2019. The technology of fatty substances. Available from iterg.com/wp-content/uploads/2019/02/FicheinformationN2.pdf.
- Jaroszewski, J.W., 1998. Compound from the cotton plant. In Cotton. Berlin, Heidelberg: Springer. pp: 335-349.
- Jayaraj, R., P. Megha and P. Sreedev, 2016. Organochlorine pesticides, their toxic effects on living organisms and their fate in the environment. Interdisciplinary Toxicology, 9(3-4): 90-100. Available at: <https://doi.org/10.1515/intox-2016-0012>.
- Jayashree, T. and C. Subramanyam, 2000. Oxidative stress as a prerequisite for aflatoxin production by aspergillus parasiticus. Free Radical Biology and Medicine, 29(10): 981-985. Available at: [https://doi.org/10.1016/s0891-5849\(00\)00398-1](https://doi.org/10.1016/s0891-5849(00)00398-1).
- Joseph, A., S. Matlin and P. Knox, 1986. Cytotoxicity of enantiomers of gossypol. British Journal of Cancer, 54: 511-513. Available at: <https://doi.org/10.1038/bjc.1986.205>.
- Jouve, J.L., 1993. The microbiological quality of food. Mastery and criteria. Polytechnica, 7: 124-125.
- Judde, A., 2004. Prevention of fatty acid oxidation in a cosmetic product: Mechanisms, consequences, means of measurement, which antioxidants for which applications? Oilseeds, Fat, Lipids, 11(6): 414-418.
- Kamal-Eldin, A. and L.A. Appelqvist, 1996. Aldehydic acids in frying oils: Formation, toxicological significance and analysis. Fats and Oils, 47(5): 342-348. Available at: <https://doi.org/10.3989/gya.1996.v47.i5.879>.
- Kamimura, H., M. Nishijima, S. Tabata, K. Yasuda, H. Ushiyama and T. Nishima, 1986. Survey of mycotoxins contamination in edible oil and fate of mycotoxins during oil-refining processes. Food Hygiene and Safety Science (Shokuhin Eiseigaku Zasshi), 27(1): 59-63_51. Available at: <https://doi.org/10.3358/shokueishi.27.59>.
- Kamimura, H., M. Nishijima, S. Tabata, K. Yasuda, H. Ushiyama and T. Nishima, 1986. Survey of mycotoxins contamination in edible oil and fate of mycotoxins during oil-refining processes. Food Hygiene and Safety Science (Shokuhin Eiseigaku Zasshi), 27(1): 59-63_51.
- Kanoi, F., 2004. Agri-inputs marketing research. Cotton crop track. Cotton Crop Track, A Report on Seeds. Chennai, 2005.
- Keller, S.E., T.M. Sullivan and S. Chirtel, 1997. Factors affecting the growth of Fusarium proliferatum and the production of fumonisin B 1: Oxygen and pH. Journal of Industrial Microbiology and Biotechnology, 19(4): 305-309. Available at: <https://doi.org/10.1038/sj.jim.2900466>.
- Kim, H.J. and D.B. Min, 2008. Tocopherol stability and prooxidant mechanisms of oxidized tocopherols in lipids. Food Lipids: Chemistry, Nutrition, and Biotechnology, 3: 435-448.
- Klere, J., 1992. History of fatty substances. Manual of fatty substances, Ed Lavoisier. Paris.
- Koné, S., 2001. Modern small and very small scale oilseed processing units: Performance and limits. Info gate, gtz. 12. Available from <https://docplayer.fr/6836461-Unites-modernes-de-transformation-des-oleagineux-a-petite-et-tres-petite-echelle-performances-et-limites.html>.
- Krieger, R., 2001. Handbook of pesticide toxicology: Principles and agents. Academic Press. Available from https://books.google.fr/books?hl=fr&lr=&id=PzMWogFy_wgC&oi=fnd&pg=PP1&dq=Handbook+of+pesticide+to

- xicology:+Principles+and+agents.&ots=VfZsqfr1F&sig=rPg51zrerjzRjYrp7n2fu-
pEHD0#v=onepage&q=Handbook%20of%20pesticide%20toxicology%3A%20Principles%20and%20agents.&f=false.
- Kubow, S., 1990. Toxicity of dietary lipid peroxidation products. *Trends in Food Science & Technology*, 1: 67-71. Available at: [https://doi.org/10.1016/0924-2244\(90\)90049-5](https://doi.org/10.1016/0924-2244(90)90049-5).
- Kuiper-Goodman, T. and P.M. Scott, 1989. Risk assessment of the mycotoxin ochratoxin A. *Biomedical and Environmental Sciences*, 2(3): 179-248.
- Lacey, J., 1991. Natural occurrence of mycotoxins in growing and conserved forage crops. *Natural Occurrence of Mycotoxins in Growing and Conserved Forage Crops*: 363-397. Available from <https://www.cabdirect.org/cabdirect/abstract/19911210324>.
- Lacoste, F., H. Lechat, X. Pages, J.N. Arnaud, B. E. Brenne, B. Soulet, C. Camisuli, S. Birot, J. Fazeuilh and J. Escabasse, 2005. Control of undesirable compounds in vegetable oils and establishment of observatories. *Oilseeds, Fats, Fat*, 12(5-6): 372-377. Available from <https://doi.org/10.1051/ocl.2005.0372>.
- Laguerre, M., L.J. López-Giraldo, J. Lecomte, M. Pina and P. Villeneuve, 2007. Tools for in vitro evaluation of antioxidant capacity. *Oilseeds, Fats, Lipids*, 14(5): 278-292.
- Lecerf, J.M., 2011. Vegetable oils: Particularities and usefulness: Vegetable oils: Particularities and usefulness. *Medicine for Metabolic Diseases*, 5(3): 257-262. Available at: [https://doi.org/10.1016/S1957-2557\(11\)70237-1](https://doi.org/10.1016/S1957-2557(11)70237-1).
- Leng, P., Z. Zhang, G. Pan and M. Zhao, 2011. Applications and development trends in biopesticides. *African Journal of Biotechnology*, 10(86): 19864-19873. Available at: <https://doi.org/10.5897/ajbx11.009>.
- Lentza-Rizos, C., E. Avramides and F. Cherasco, 2001. Low-temperature clean-up method for the determination of organophosphorus insecticides in olive oil. *Journal of Chromatography A*, 912(1): 135-142. Available at: [https://doi.org/10.1016/S0021-9673\(01\)00527-1](https://doi.org/10.1016/S0021-9673(01)00527-1).
- Lerma-García, M.a.J.s., V. Concha-Herrera, J.M. Herrero-Martínez and E.F. Simó-Alfonso, 2009. Classification of extra virgin olive oils produced at la comunitat valenciana according to their genetic variety using sterol profiles established by high-performance liquid chromatography with mass spectrometry detection. *Journal of Agricultural and Food Chemistry*, 57(22): 10512-10517. Available at: <https://doi.org/10.1021/jf902322c>.
- Li, L., Z. Zhou, C. Pan, C. Qian, S. Jiang and F. Liu, 2007. Determination of organophosphorus pesticides in soybean oil, peanut oil and sesame oil by low-temperature extraction and GC-FPD. *Chromatographia*, 66(7-8): 625-629. Available at: <https://doi.org/10.1365/s10337-007-0349-9>.
- Lindberg, M., R. Naqvi, S. Matlin, R. Zhou, G. Bialy and R. Blye, 1987. Comparative anti-fertility effects of gossypol enantiomers in male hamsters. *International Journal of Andrology*, 10(4): 619-623. Available at: <https://doi.org/10.1111/j.1365-2605.1987.tb00361.x>.
- Liu, B., 1957. A modest proposal for the use of crude cottonseed oil for antifertility. *Shanghai Journal of Traditional Chinese Medicine*, 6: 43.
- LNE, 2008. Pesticides. 15. Available from https://metrologie-francaise.lne.fr/sites/default/files/media/document/07_pesticides-tracabilite-mesure.pdf.
- Lordelo, M., A. Davis, M. Calhoun, M. Dowd and N. Dale, 2005. Relative toxicity of gossypol enantiomers in broilers. *Poultry Science*, 84(9): 1376-1382. Available at: <https://doi.org/10.1093/ps/84.9.1376>.
- Louis, K., 2013. Synthesis and functionalization of aldehydes resulting from the cleavage of unsaturated fatty esters. Doctoral Thesis, University of Poitiers, France.
- Luchese, R.H. and W. Harrigan, 1993. Biosynthesis of aflatoxin—the role of nutritional factors. *Journal of Applied Bacteriology*, 74(1): 5-14. Available at: <https://doi.org/10.1111/j.1365-2672.1993.tb02989.x>.
- Lyman, C.M., B.P. Baliga and M.W. Slay, 1959. Reactions of proteins with gossypol. *Archives of Biochemistry and Biophysics*, 84(2): 486-497. Available at: [https://doi.org/10.1016/0003-9861\(59\)90610-1](https://doi.org/10.1016/0003-9861(59)90610-1).
- Maata, N., B. Kartah, H. Harhar, S. Gharby, E. Benazzouz, D. Guillaume and Z. Charrouf, 2011. Detection of adulteration of argan oil by virgin and refined vegetable oils. *First International Congress on the Argan Tree*. pp: 15-17.

- Magan, N. and D. Aldred, 2005. Conditions of formation of ochratoxin A in drying, transport and in different commodities. *Food Additives and Contaminants*, 22(s1): 10-16. Available at: <https://doi.org/10.1080/02652030500412154>.
- Mahmoudi, R. and R. Norian, 2015. Aflatoxin B1 and M1 contamination in cow feeds and milk from Iran. *Food and Agricultural Immunology*, 26(1): 131-137. Available at: <https://doi.org/10.1080/09540105.2013.876977>.
- Mannon, J. and E. Johnson, 1985. Fungi down on the farm. *New Scientist*, 105: 12-16.
- Marasas, W.F.O., T.S. Kellerman, W.C. Gelderblom, P.G. Thiel, J.J. Van der Lugt and J.A. Coetzer, 1988. Leukoencephalomalacia in a horse induced by fumonisin B- isolated from fusarium moniliforme. Available from <https://repository.up.ac.za/bitstream/handle/2263/42389/43marasas1988.pdf?sequence=1&isAllowed=y>.
- Marin, S., A. Ramos, G. Cano-Sancho and V. Sanchis, 2013. Mycotoxins: Occurrence, toxicology, and exposure assessment. *Food and Chemical Toxicology*, 60: 218-237. Available at: <https://doi.org/10.1016/j.fct.2013.07.047>.
- Markman, A.L. and V.P. Rzhikhin, 1969. Gossypol and its derivatives (Translated from Russian). Jerusalem: Israel Program for Scientific Translations.
- Martin, J., A. Ba, P. Dimanche and R. Schilling, 1999. How to fight aflatoxin contamination of peanuts? Experiments conducted in Senegal. *Agriculture and Development*, 23: 58-67.
- Matlin, S., R. Zhou, G. Bialy, R. Blye, R. Naqvi and M. Lindberg, 1985. (-)-gossypol: An active male antifertility agent. *Contraception*, 31(2): 141-149. Available at: [https://doi.org/10.1016/0010-7824\(85\)90027-7](https://doi.org/10.1016/0010-7824(85)90027-7).
- Mawussi, G., 2008. Environmental balance of the use of organochlorine pesticides in cotton, coffee and cocoa crops in Togo and search for alternatives by evaluating the insecticidal power of extracts of local plants against the bark beetle (*Hypothenemus hampei* Ferrari). (Doctoral Dissertation, INPT).
- Mazet, A., 2005. Ecotoxicological and environmental study of the Drôme river: Application to the survival of the otter. Doctoral Thesis of the Joseph-Fourier-Grenoble I University.
- Menegaux, F., A. Baruchel, Y. Bertrand, B. Lescoeur, G. Leverger, B. Nelken, D. Sommelet, D. Hémon and J. Clavel, 2006. Household exposure to pesticides and risk of childhood acute leukaemia. *Occupational and Environmental Medicine*, 63(2): 131-134. Available at: <https://doi.org/10.1136/oem.2005.023036>.
- Mirghani, M. and M.Y. Che, 2003. A new method for determining gossypol in cottonseed oil by FTIR spectroscopy. *Journal of the American Oil Chemists' Society*, 80(7): 625-628. Available at: <https://doi.org/10.1007/s11746-003-0749-2>.
- Monbaliu, S., C. Van Poucke, C.I. Detavernier, F. Dumoulin, M. Van De Velde, E. Schoeters, S. Van Dyck, O. Averkieva, C. Van Peteghem and S. De Saeger, 2010. Occurrence of mycotoxins in feed as analyzed by a multi-mycotoxin LC-MS/MS method. *Journal of Agricultural and Food Chemistry*, 58(1): 66-71. Available at: <https://doi.org/10.1021/jf903859z>.
- Moreno-González, D., J.F. Huertas-Pérez, A.M. García-Campaña and L. Gámiz-Gracia, 2014. Determination of carbamates in edible vegetable oils by ultra-high performance liquid chromatography–tandem mass spectrometry using a new clean-up based on zirconia for QuEChERS methodology. *Talanta*, 128: 299-304. Available at: <https://doi.org/10.1016/j.talanta.2014.04.045>.
- Murphy, P.A., S. Hendrich, C. Landgren and C.M. Bryant, 2006. Food mycotoxins: An update. *Journal of Food Science*, 71(5): R51-R65. Available at: <https://doi.org/10.1111/j.1750-3841.2006.00052.x>.
- Nabizadeh, S., S. Shoebibi, G. Jahed-Khaniki, R. Nabizadeh-Nodeh and E. Shokoohi, 2015. Validation of simultaneous analysis method for determination of aflatoxins in olive oil by high performance liquid chromatography fluorescence detector. *Journal of Food Safety and Hygiene*, 1(2): 63-68.
- National Cancer Institute, 2014. Pesticides and risks of cancer. State of knowledge as of April 2014: 12. Available from https://www.cancer-environnement.fr/Portals/0/Documents%20PDF/Rapport/INCa/FR_Pesticides_et_risques_de_cancers_2014.pdf.
- Njobeh, P.B., M.F. Dutton and H.A. Makun, 2010. Mycotoxins and human health: Significance, prevention and control. In *Smart Biomolecules in Medicine*. VBRI Press India. pp: 132-177. Available from file:///C:/Users/nghf/Downloads/Chapter_6Njobehetal.pdf.

- Nolen, G.A., J.C. Alexander and N.R. Artman, 1967. Long-term rat feeding study with used frying fats. *The Journal of Nutrition*, 93(3): 337-348. Available at: <https://doi.org/10.1093/jn/93.3.337>.
- Nomeir, A. and M. Abou-Donia, 1982. Gossypol: High-performance liquid chromatographic analysis and stability in various solvents. *Journal of the American Oil Chemists' Society*, 59(12): 546-549. Available at: <https://doi.org/10.1007/bf02636320>.
- Nwanguma, B.C., A.C. Achebe, L.U.S. Ezeanyika and L.C. Eze, 1999. Toxicity of oxidized fats ii: Tissue levels of lipid peroxides in rats fed a thermally oxidized corn oil diet. *Food and chemical Toxicology*, 37(4): 413-416. Available at: [https://doi.org/10.1016/S0278-6915\(99\)00023-X](https://doi.org/10.1016/S0278-6915(99)00023-X).
- Nzikou, J.M., L. Matos, J.E. Moussounga, C.B. Ndangui, N.P. Pambou-Tobi, E.M. Bandzouzi, A. Kimbonguila, M. Linder and S. Desobry, 2009. Study of oxidative and thermal stability of vegetable oils during frying. *Research Journal of Applied Science*, 4(2): 94-100.
- Oatley, J.T., M.D. Rarick, G.E. Ji and J.E. Linz, 2000. Binding of aflatoxin B1 to bifidobacteria in vitro. *Journal of Food Protection*, 63(8): 1133-1136. Available at: <https://doi.org/10.4315/0362-028x-63.8.1133>.
- Oliva, A., A. Spira and L. Multigner, 2001. Contribution of environmental factors to the risk of male infertility. *Human Reproduction*, 16(8): 1768-1776. Available at: <https://doi.org/10.1093/humrep/16.8.1768>.
- Oliver, C.L., M.B. Miranda, S. Shangary, S. Land, S. Wang and D.E. Johnson, 2005. (-)-Gossypol acts directly on the mitochondria to overcome Bcl-2-and Bcl-XL-mediated apoptosis resistance. *Molecular Cancer Therapeutics*, 4(1): 23-31.
- Ollivier, D., 2003. Research on adulteration in vegetable oils: Application to the quality of virgin oils and in particular olive oil. *Oilseeds, Fat, Lipids*, 10(4): 315-320.
- Pages, X., O. Morin, C. Birot, M. Gaud, S. Fazeuilh and M. Gouband, 2010. Refining of oils and fatty substances and elimination of contaminants. *Oilseeds, Fats, Fats*, 17(2): 86-99.
- Panigrahi, S., V.E. Plumb and D.H. Machin, 1989. Effects of dietary cottonseed meal, with and without iron treatment, on laying hens. *British Poultry Science*, 30(3): 641-651. Available at: <https://doi.org/10.1080/00071668908417187>.
- Papachristou, A. and P. Markaki, 2004. Determination of ochratoxin A in virgin olive oils of Greek origin by immunoaffinity column clean-up and high-performance liquid chromatography. *Food Additives and Contaminants*, 21(1): 85-92. Available at: <https://doi.org/10.1080/02652030310001632547>.
- Park, D., L. Lee, R. Price and A. Pohland, 1988. Review of the decontamination of aflatoxins by ammoniation: Current status and regulation. *Journal-Association of official analytical chemists*, 71(4): 685-703.
- Parker, W.A. and D. Melnick, 1966. Absence of aflatoxin from refined vegetable oils. *Journal of the American Oil Chemists Society*, 43(11): 635-638. Available at: <https://doi.org/10.1007/bf02640803>.
- Pearson, A.M., J.I. Gray, A.M. Wolzak and N.A. Horenstein, 1983. Safety implications of oxidized lipids in muscle foods. *Food Technology (USA)*.
- Peers, F.G. and C.A. Linsell, 1975. Aflatoxin contamination and its heat stability in Indian cooking oils. *Tropical Science*, 17(4): 229-232.
- Pierides, M., H. El-Nezami, K. Peltonen, S. Salminen and J. Ahokas, 2000. Ability of dairy strains of lactic acid bacteria to bind aflatoxin M1 in a food model. *Journal of Food Protection*, 63(5): 645-650. Available at: <https://doi.org/10.4315/0362-028x-63.5.645>.
- Pitt, J.I., 1996. What are mycotoxins? *Australian Mycotoxin Newsletter*, 7(4).
- Polgár, L., B. Kmeľár, J.F. García-Reyes and P. Fodor, 2012. Comprehensive evaluation of the clean-up step in QuEChERS procedure for the multi-residue determination of pesticides in different vegetable oils using LC-MS/MS. *Analytical Methods*, 4(4): 1142-1148. Available at: <https://doi.org/10.1039/c2ay05543k>.
- Polsky, B., S.J. Segal, P.A. Baron, J.W. Gold, H. Ueno and D. Armstrong, 1989. Inactivation of human immunodeficiency virus in vitro by gossypol. *Contraception*, 39(6): 579-587. Available at: [https://doi.org/10.1016/0010-7824\(89\)90034-6](https://doi.org/10.1016/0010-7824(89)90034-6).

- Proctor, J., H. O'Neill, H. Reilich, R. Levi and W. Pons, 1968. Physiological evaluation of solvent-treated cottonseed meals in rations for laying hens. *Journal of the American Oil Chemists' Society*, 45(5): 393-396. Available at: <https://doi.org/10.1007/bf02667118>.
- Qi, X., 2010. Development of a matrix solid-phase dispersion-sonication extraction method for the determination of fungicides residues in ginseng extract. *Food Chemistry*, 121(3): 758-762. Available at: <https://doi.org/10.1016/j.foodchem.2009.12.080>.
- Qian, S. and Z. Wang, 1984. Gossypol: A potential antifertility agent for males. *Annual Review of Pharmacology and Toxicology*, 24(1): 329-360. Available at: <https://doi.org/10.1146/annurev.pa.24.040184.001553>.
- Quin, L.D., 2000. A guide to organophosphorus chemistry. John Wiley and Sons. Available from: <https://books.google.fr/books?hl=fr&lr=&id=3ATQyJZBjy0C&oi=fnd&pg=PR9&dq=A+guide+to+organophosphorus+chemistry&ots=bGjXEMQgE6&sig=OBhqNWsutyVIyHCjEAygnEE0yb0#v=onepage&q=A%20guide%20to%20organophosphorus%20chemistry&f=false>.
- Rahma, E.H. and M.N. Rao, 1984. Gossypol removal and functional properties of protein produced by extraction of glanded cottonseed with different solvents. *Journal of Food Science*, 49(4): 1057-1060. Available at: <https://doi.org/10.1111/j.1365-2621.1984.tb10391.x>.
- Ravelo-Pérez, L.M., J. Hernández-Borges, T.M. Borges-Miquel and M.A. Rodríguez-Delgado, 2008. Solid-phase micro-extraction and sample stacking micellar electrokinetic chromatography for the analysis of pesticide residues in red wines. *Food Chemistry*, 111(3): 764-770. Available at: <https://doi.org/10.1016/j.foodchem.2008.04.020>.
- Razzazi-Fazeli, E., B. Rabus, B. Cecon and J. Böhm, 2002. Simultaneous quantification of a-trichothecene mycotoxins in grains using liquid chromatography-atmospheric pressure chemical ionisation mass spectrometry. *Journal of Chromatography A*, 968(1-2): 129-142. Available at: [https://doi.org/10.1016/s0021-9673\(02\)00957-3](https://doi.org/10.1016/s0021-9673(02)00957-3).
- Reboux, G., 2006. Mycotoxins: Health effects and interactions with other organic components. *French Review of Allergology and Clinical Immunology*, 46(3): 208-212. Available at: <https://doi.org/10.1016/j.allerg.2006.01.036>.
- Repetto, R. and S.S. Baliga, 1996. Pesticides and the immune system: The public health risks. World Resources Institute.
- Richard, J.L., G.A. Payne, A.E. Desjardins, C. Maragos, W. Norred and J. Pestka, 2003. Mycotoxins: Risks in plant, animal and human systems. CAST Task Force Report, 139: 101-103.
- Riemersma, R.A., 2002. Analysis and possible significance of oxidized lipids in food. *European Journal of Lipid Science and Technology*, 104(7): 419-420. Available at: [https://doi.org/10.1002/1438-9312\(200207\)104:7<419::aid- ejlt419>3.0.co;2-s](https://doi.org/10.1002/1438-9312(200207)104:7<419::aid- ejlt419>3.0.co;2-s).
- Robertson, A.E., 2005. Risk of aflatoxin contamination increases with hot and dry growing conditions. Available from <https://lib.dr.iastate.edu/cgi/viewcontent.cgi?article=2369&context=cropnews>.
- Roszkó, M., A. Szterk, K. Szymczyk and B. Waszkiewicz-Robak, 2012. PAHs, PCBs, PBDEs and pesticides in cold-pressed vegetable oils. *Journal of the American Oil Chemists' Society*, 89(3): 389-400. Available at: <https://doi.org/10.1007/s11746-011-1926-5>.
- Sahay, S.S. and T. Prasad, 1990. The occurrence of aflatoxins in mustard and mustard products. *Food Additives & Contaminants*, 7(4): 509-513. Available at: <https://doi.org/10.1080/02652039009373912>.
- Samarajeewa, U., T. Gamage and S. Arseculeratne, 1983. Aflatoxin contamination of coconut oil from small scale mills: Toxin levels and their relation to free fatty acid content. *Journal of the National Science Foundation of Sri Lanka*, 11(2): 203 - 210. Available at: <https://doi.org/10.4038/jnsfsr.v11i2.8383>.
- Schmidely, P. and D. Sauvant, 2001. Butyrous rate and fat composition of milk in small ruminants: Effects of the intake of fat or concentrated feed. *INRA Animal Production*, 14(5): 337-354.
- Scott, P.M., 1998. Industrial and farm detoxification processes for mycotoxins. *Journal of Veterinary Medicine (France)*, 149: 543-548.

- Scudamore, K.A. and C.T. Livesey, 1998. Occurrence and significance of mycotoxins in forage crops and silage: A review. *Journal of the Science of Food and Agriculture*, 77(1): 1-17. Available at: [https://doi.org/10.1002/\(sici\)1097-0010\(199805\)77:1<1::aid-jsfa9>3.0.co;2-4](https://doi.org/10.1002/(sici)1097-0010(199805)77:1<1::aid-jsfa9>3.0.co;2-4).
- Sharmili, K., S. Jinap and R. Sukor, 2016. Development, optimization and validation of QuEChERS based liquid chromatography tandem mass spectrometry method for determination of multi-mycotoxin in vegetable oil. *Food Control*, 70: 152-160. Available at: <https://doi.org/10.1016/j.foodcont.2016.04.035>.
- Sheen, L.Y., H.W. Chen, Y.L. Kung, C.T. Liu and C.K. Lii, 1999. Effects of garlic oil and its organosulfur compounds on the activities of hepatic drug-metabolizing and antioxidant enzymes in rats fed high-and low-fat diets. *Nutrition and Cancer*, 35(2): 160-166. Available at: https://doi.org/10.1207/s15327914nc352_10.
- Shelley, M.D., L. Hartley, R.G. Fish, P. Groundwater, J.J.G. Morgan, D. Mort and A. Evans, 1999. Stereo-specific cytotoxic effects of gossypol enantiomers and gossypolone in tumour cell lines. *Cancer Letters*, 135(2): 171-180. Available at: [https://doi.org/10.1016/S0304-3835\(98\)00302-4](https://doi.org/10.1016/S0304-3835(98)00302-4).
- Silva, L., J. Pinto, J. Carrola and F. Paiva-Martins, 2010. Oxidative stability of olive oil after food processing and comparison with other vegetable oils. *Food Chemistry*, 121(4): 1177-1187. Available at: <https://doi.org/10.1016/j.foodchem.2010.02.001>.
- Slope, S.L., S. Wu, Z. Wu, H. Shen and X.J. Chang, 2013. Patent CN 103205311B. A method for industrially removing zearalenone out of maize germ. State Grain Administration Institute. (Granted 24 Dec 2014).
- Sobhanzadeh, E., N.K.A. Bakar, M.R.B. Abas and K. Nemat, 2011. An efficient extraction and clean-up procedure for pesticide determination in olive oil. *European Journal of Lipid Science and Technology*, 113(7): 862-869. Available at: <https://doi.org/10.1002/ejlt.201000384>.
- Spanjer, M.C., P.M. Rensen and J.M. Scholten, 2008. LC-MS/MS multi-method for mycotoxins after single extraction, with validation data for peanut, pistachio, wheat, maize, cornflakes, raisins and figs. *Food Additives and Contaminants*, 25(4): 472-489. Available at: <https://doi.org/10.1080/02652030701552964>.
- Srivastava, S., M. Siddiqui and T. Seth, 1983. Organochlorine pesticide residues in groundnut oil. *Journal of Food Science and Technology*, 20(1): 25-27.
- Staprans, I., D.A. Hardman, X.M. Pan and K.R. Feingold, 1999. Effect of oxidized lipids in the diet on oxidized lipid levels in postprandial serum chylomicrons of diabetic patients. *Diabetes Care*, 22(2): 300-306. Available at: <https://doi.org/10.2337/diacare.22.2.300>.
- Stoytcheva, M. and R. Zlatev, 2011. Organophosphorus pesticides analysis. *Pesticides in the modern world-Trends in Pesticides Analysis* (M. Stoytcheva, Ed.). InTech, Croatia. pp: 143-164. Available from https://www.researchgate.net/profile/Margarita_Stoytcheva/publication/275884378_Pesticides_in_the_Modern_World_Trends_in_Pesticides_Analysis/links/5550d17008ae12808b390933.pdf#page=156.
- Sun, Y.E., W.D. Wang, H.W. Chen and C. Li, 2011. Autoxidation of unsaturated lipids in food emulsion. *Critical Reviews in Food Science and Nutrition*, 51(5): 453-466. Available at: <https://doi.org/10.1080/10408391003672086>.
- Sweeney, M.J. and A.D. Dobson, 1998. Mycotoxin production by aspergillus, fusarium and penicillium species. *International Journal of Food Microbiology*, 43(3): 141-158. Available at: [https://doi.org/10.1016/s0168-1605\(98\)00112-3](https://doi.org/10.1016/s0168-1605(98)00112-3).
- Tabuc, C., 2007. Fungal flora of different substrates and optimal conditions for the production of mycotoxins. Doctoral Dissertation.
- Tantaoui-Elaraki, A. and B. Le Tutour, 1985. Possible mycotoxin contamination of olives and olive products: Latest developments. *Oleagineux*, 40(8): 451-454.
- Thakare, S.K., R.S. Dewan and K.C. Gulati, 1969. Build-up of DDT in human fat-oils and oilseeds as possible source. *Pesticide*, 3: 13-14.
- Thompson, C. and S.E. Henke, 2000. Effect of climate and type of storage container on aflatoxin production in corn and its associated risks to wildlife species. *Journal of Wildlife Diseases*, 36(1): 172-179. Available at: <https://doi.org/10.7589/0090-3558-36.1.172>.

- Tian, X., J.-X. Ruan, J.-Q. Huang, C.-Q. Yang, X. Fang, Z.-W. Chen, H. Hong, L.-J. Wang, Y.-B. Mao and S. Lu, 2018. Characterization of gossypol biosynthetic pathway. *Proceedings of the National Academy of Sciences*, 115(23): E5410-E5418. Available at: <https://doi.org/10.1073/pnas.1805085115>.
- Tomlin, C.D.S., 2003. *The pesticide manual: A world compendium*. 13th Edn., Alton Hampshire: British Crop Protection Council.
- Tozlovanu, M., 2008. Evaluation of the risk of food contamination with nephrotoxic and carcinogenic mycotoxins (notably ochratoxin A): validation of exposure and effect biomarkers. Doctoral Thesis.
- Vaitilingom, G., 2007. Extraction, packaging and use of pure fuel vegetable oils. Challenges and perspectives of biofuels for Africa. Available from https://www.researchgate.net/profile/Gilles_Vaitilingom/publication/268419017_Extraction_conditionnement_et_utilisation_des_Huiles_Vegeales_Pures_Carburant/links/5512eddc0cf2ffb65630ce86.pdf.
- Van Duijn, G. and G. Den Dekker, 2010. Unilever food safety assurance system for refined vegetable oils and fats. *Oléagineux, Corps gras, Lipides*, 17(2): 100-103. Available at: <https://doi.org/10.1051/ocl.2010.0297>.
- Vander, J.D.L. and R. Royer, 2000. Gossypol prototype of inhibitors targeted to dinucleotide folds. *Current Medicinal Chemistry*, 7(4): 479-498. Available at: <https://doi.org/10.2174/0929867003375119>.
- Velez, D.L.C.J.F., E. Rachou, M.T. Martelot, B. Ducot, L. Multigner and P.F. Thonneau, 2001. Male infertility risk factors in a French military population. *Human Reproduction*, 16(3): 481-486. Available at: <https://doi.org/10.1093/humrep/16.3.481>.
- Villier, A. and C. Genot, 2006. Physico-chemical and sensory approach to the oxidation of lipids in emulsions. *Oleagineux, Corps Gras, Lipides*, 13(4): 1-7.
- Vine, M.F., L. Stein, K. Weigle, J. Schroeder, D. Degnan, C.-K.J. Tse and L. Backer, 2001. Plasma 1, 1-dichloro-2, 2-bis (p-chlorophenyl) ethylene (DDE) levels and immune response. *American Journal of Epidemiology*, 153(1): 53-63. Available at: <https://doi.org/10.1093/aje/153.1.53>.
- Vix, H., P. Eaves, H. Gardner and M. Lambou, 1971. Degossypolized cottonseed flour—the liquid cyclone process. *Journal of the American Oil Chemists' Society*, 48(10): 611-615. Available at: <https://doi.org/10.1007/bf02544573>.
- Waites, G., C. Wang and P. Griffin, 1998. Gossypol: Reasons for its failure to be accepted as a safe, reversible male antifertility drug. *International Journal of Andrology*, 21(1): 8-12. Available at: <https://doi.org/10.1046/j.1365-2605.1998.00092.x>.
- Waites, G.M.H., 1986. Regulation of male fertility: Recent progress. *Bulletin of the World Health Organization*, 64(4): 493.
- Wang, J., L. Tao, X. Wu, L. Lin, J. Wu, M. Wang and G. Zhang, 1992. Differential binding of (+) and (-) gossypol to plasma protein and their entry into rat testis. *Reproduction*, 95(1): 277-282. Available at: <https://doi.org/10.1530/jrf.0.0950277>.
- Wang, M.-Z., J.-S. Wang, B.-L. Li and F.-Y. GAO, 1985. Determination of gossypol with high performance liquid chromatography. *Acta Pharmaceutica Sinica*, 20: 682-687.
- Warner, K., E.N. Frankel and T.L. Mounts, 1989. Flavor and oxidative stability of soybean, sunflower and low erucic acid rapeseed oils. *Journal of the American Oil Chemists' Society*, 66(4): 558-564. Available at: <https://doi.org/10.1007/bf02885448>.
- Wenzl, T., E. Prettnner, K. Schweiger and F.S. Wagner, 2002. An improved method to discover adulteration of Styrian pumpkin seed oil. *Journal of Biochemical and Biophysical Methods*, 53(1-3): 193-202. Available at: [https://doi.org/10.1016/s0165-022x\(02\)00108-2](https://doi.org/10.1016/s0165-022x(02)00108-2).
- WHO, 1990. Public health impact of pesticides used in agriculture. Available from <https://apps.who.int/iris/bitstream/handle/10665/39772/9241561394.pdf?sequence=1&isAllowed=y>.
- WHO, 1991. The use of pesticides in agriculture and its consequences for public health. Available from https://apps.who.int/iris/bitstream/handle/10665/40742/9242561398_fre.pdf?sequence=1&isAllowed=y.
- WHO, 1997. Guide for the provisional calculation of the quantity of pesticide residues brought by food. Available from https://apps.who.int/iris/bitstream/handle/10665/63813/WHO_FSF_FOS_97.7_fre.pdf.

- Wild, C.P. and Y.Y. Gong, 2010. Mycotoxins and human disease: A largely ignored global health issue. *Carcinogenesis*, 31(1): 71-82. Available at: <https://doi.org/10.1093/carcin/bgp264>.
- Williams, J.H., T.D. Phillips, P.E. Jolly, J.K. Stiles, C.M. Jolly and D. Aggarwal, 2004. Human aflatoxicosis in developing countries: A review of toxicology, exposure, potential health consequences, and interventions. *The American Journal of Clinical Nutrition*, 80(5): 1106-1122. Available at: <https://doi.org/10.1093/ajcn/80.5.1106>.
- Yang, W. and S. Xiang, 1995. The separation of gossypol enantiomers by MBondapak C18 column. *Chinese Journal of Chromatography*, 13: 264-266.
- Yiannikouris, A. and J.P. Jouany, 2002. Mycotoxins in ruminant feeds, their fate and effects in animals. *Productions Animales*, 1(15): 3-16.
- Yu, F., T.N. Barry, P.J. Moughan and G.F. Wilson, 1993. Condensed tannin and gossypol concentrations in cottonseed and in processed cottonseed meal. *Journal of the Science of Food and Agriculture*, 63(1): 7-15. Available at: <https://doi.org/10.1002/jsfa.2740630103>.
- Yu, Z.H. and H.C. Chan, 1998. Gossypol as a male antifertility agent—why studies should have been continued. *International Journal of Andrology*, 21(1): 2-7. Available at: <https://onlinelibrary.wiley.com/doi/pdf/10.1046/j.1365-2605.1998.00091.x>.
- Zain, M.E., 2011. Impact of mycotoxins on humans and animals. *Journal of Saudi Chemical Society*, 15(2): 129-144. Available at: <https://doi.org/10.1016/j.jscs.2010.06.006>.
- Zhang, G., S. Ma and Z. Liu, 1999;2001. Identification of resistance to verticillium wilt of glandless cotton germplasm resources in China. *Journal of Agricultural University of Hebei*, 22: 20-24.
- Zhao, H., X. Chen, C. Shen and B. Qu, 2017. Determination of 16 mycotoxins in vegetable oils using a QuEChERS method combined with high-performance liquid chromatography-tandem mass spectrometry. *Food Additives & Contaminants: Part A*, 34(2): 255-264. Available at: <https://doi.org/10.1080/19440049.2016.1266096>.
- Zhou, R. and X. Lin, 1988. Isolation of (-)-gossypol from natural plant. *Contraception*, 37(3): 239-245. Available at: [https://doi.org/10.1016/0010-7824\(88\)90026-1](https://doi.org/10.1016/0010-7824(88)90026-1).
- Zöllner, P. and B. Mayer-Helm, 2006. Trace mycotoxin analysis in complex biological and food matrices by liquid chromatography-atmospheric pressure ionisation mass spectrometry. *Journal of Chromatography A*, 1136(2): 123-169. Available at: <https://doi.org/10.1016/j.chroma.2006.09.055>.

Views and opinions expressed in this article are the views and opinions of the author(s), Journal of Food Technology Research shall not be responsible or answerable for any loss, damage or liability etc. caused in relation to/arising out of the use of the content.